

9am, June 21st

Altitude 18.31°
Azimuth 67.04°

10am, June 21st

Altitude 25.65°
Azimuth 79.59°

11am, June 21st

Altitude 30.46°
Azimuth 94.20°

12pm, June 21st

Altitude 32.07°
Azimuth 110.19°

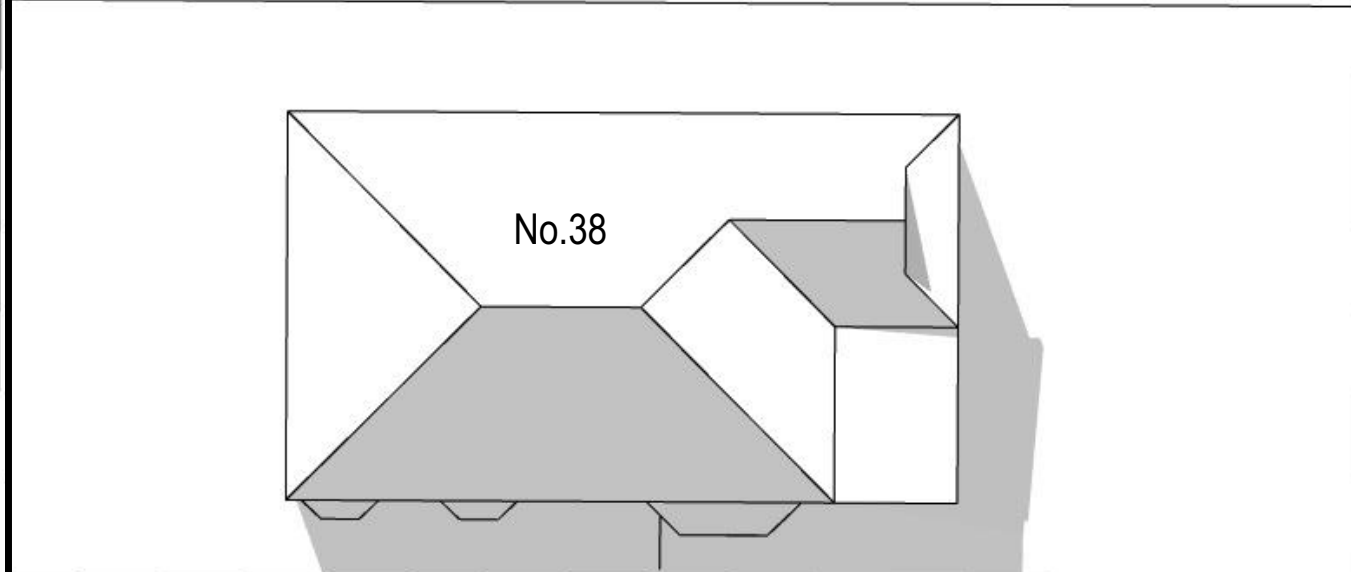
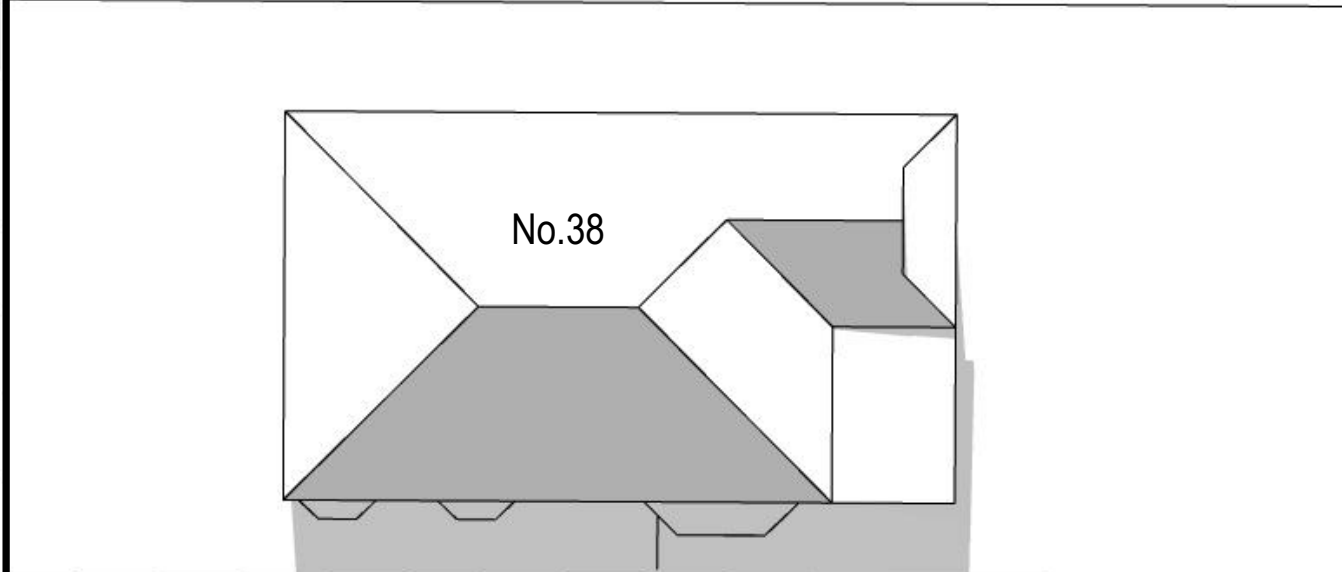
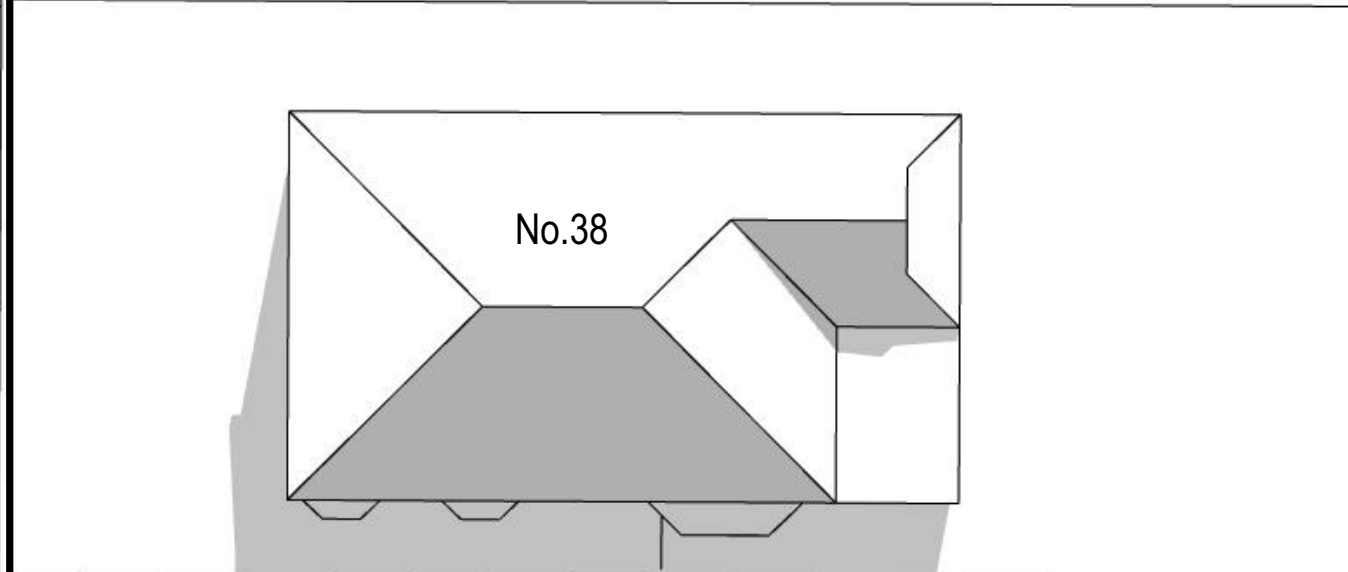
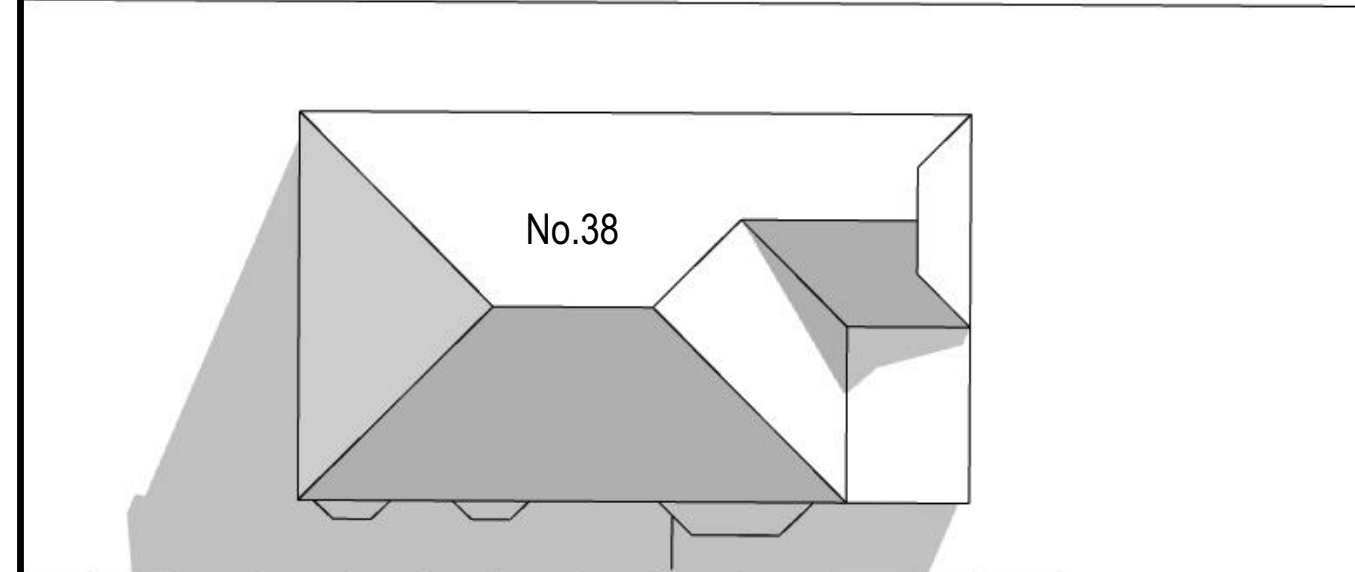
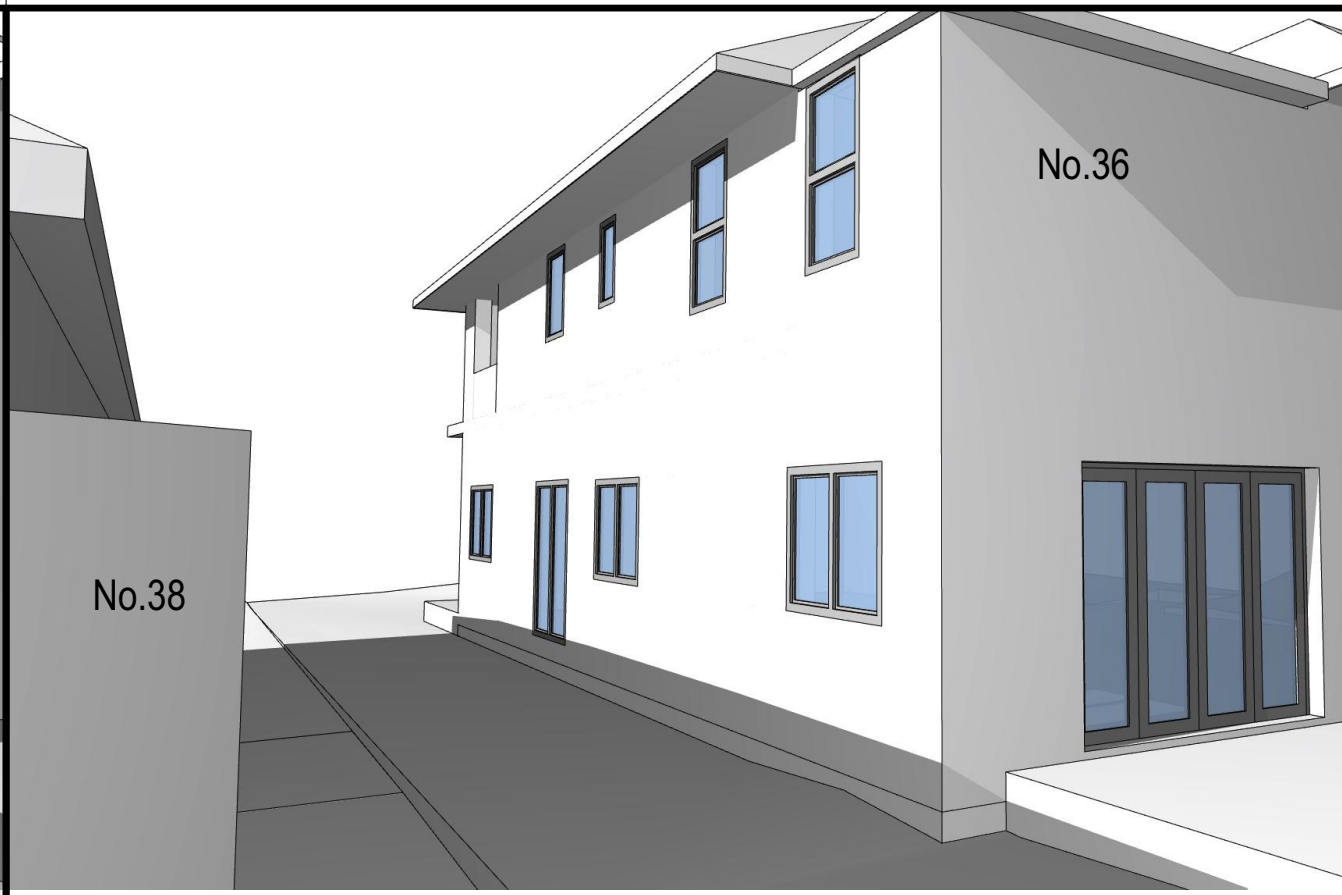
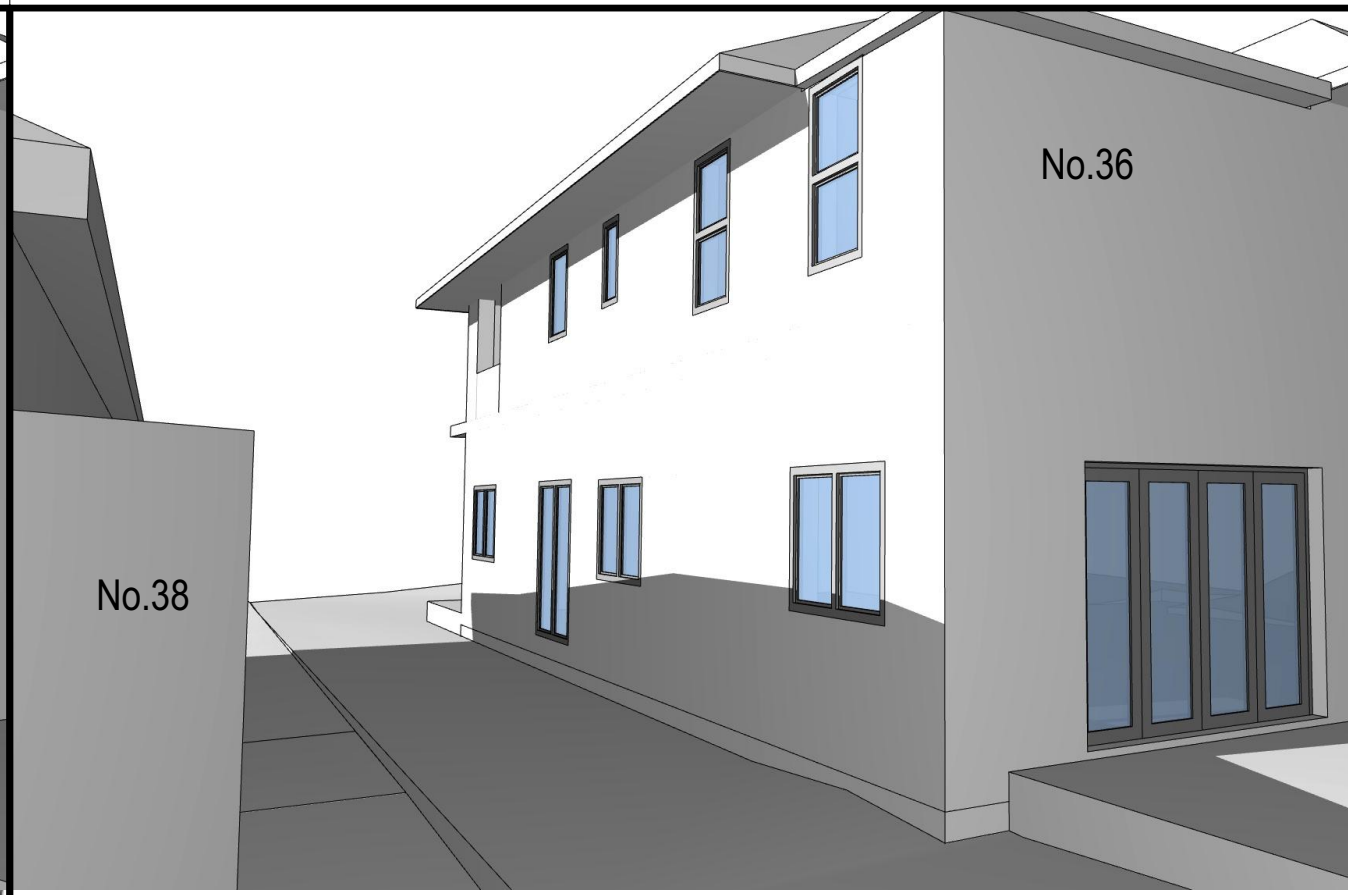

9am Existing

10am Existing

11am Existing

12pm Existing

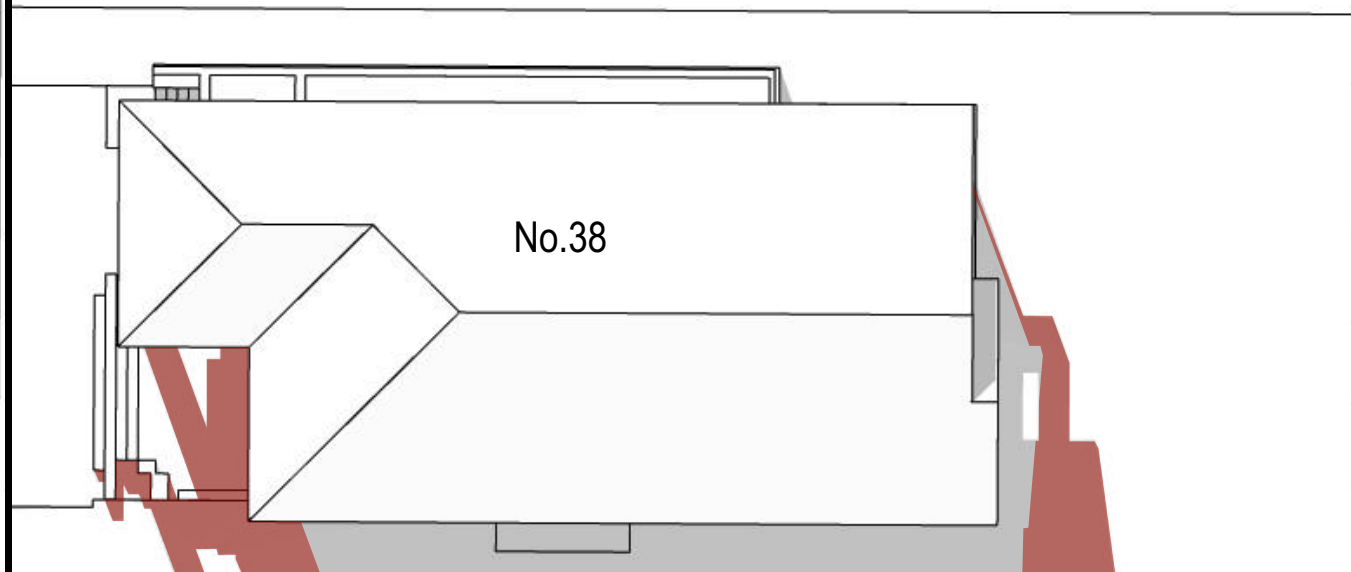
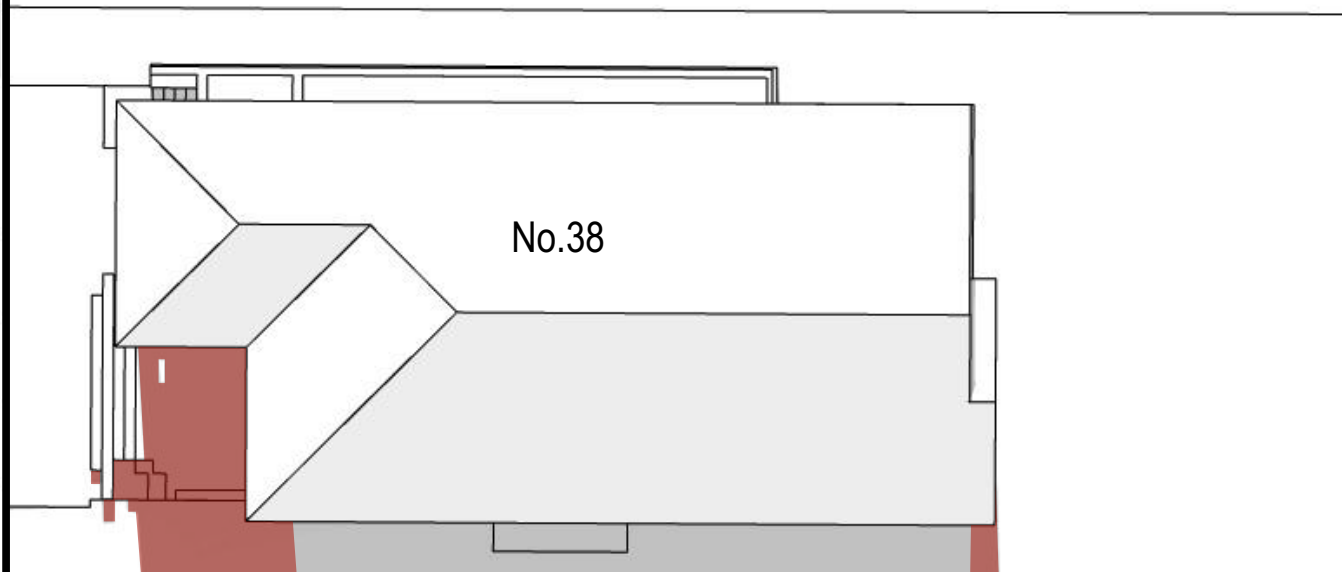
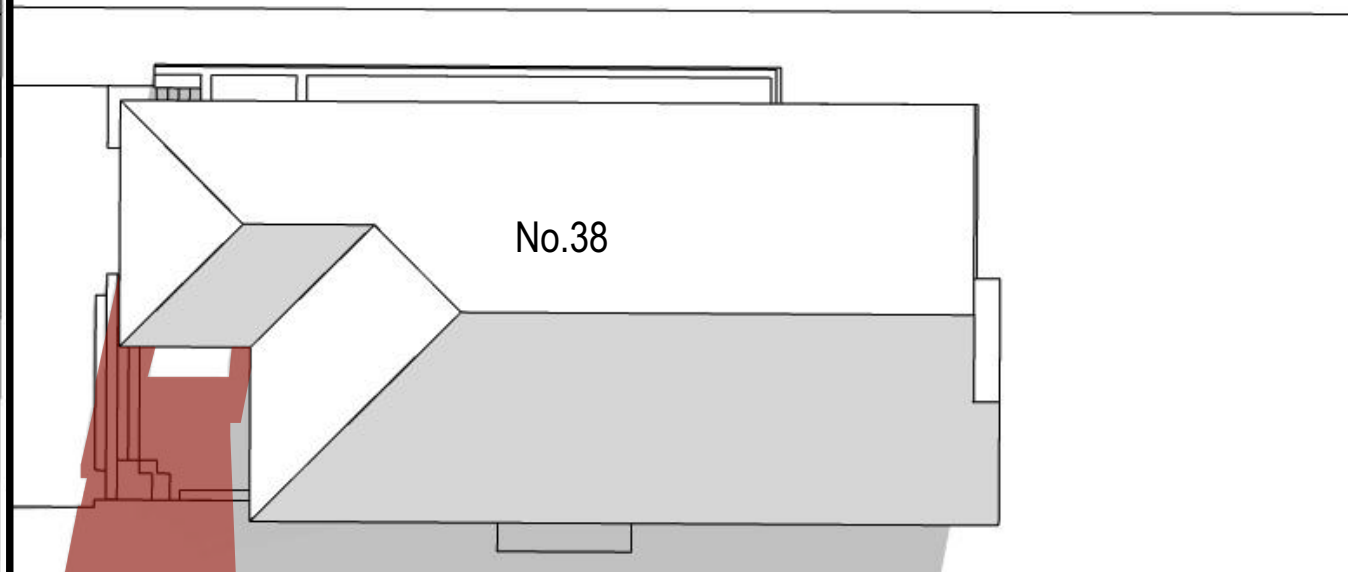
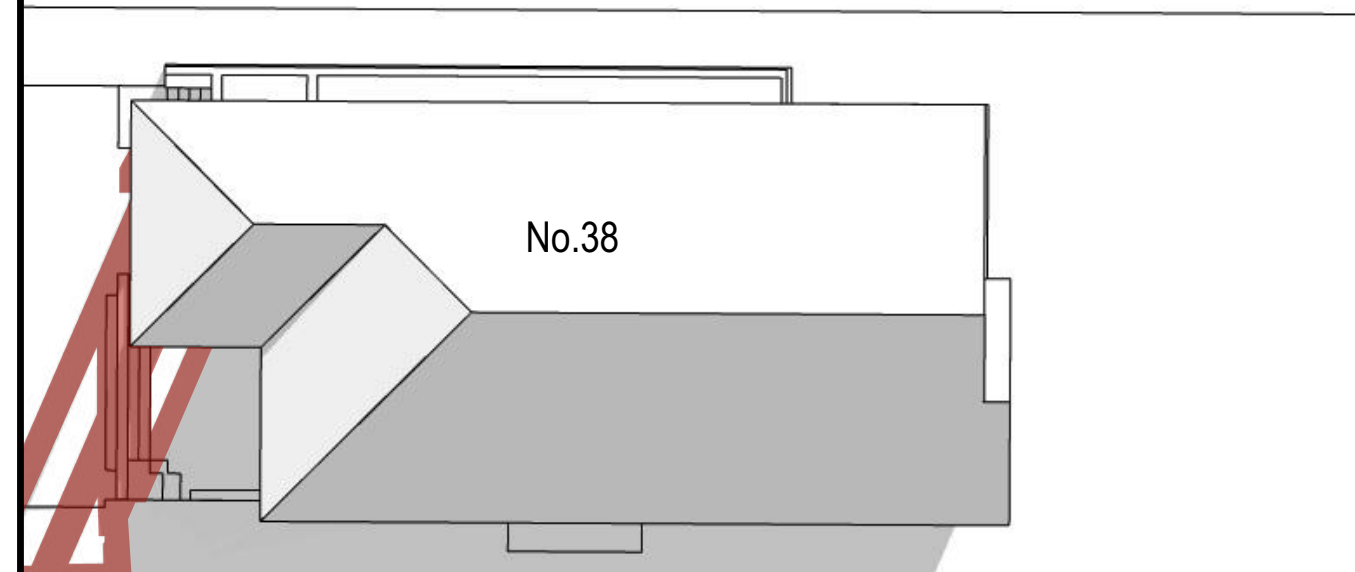
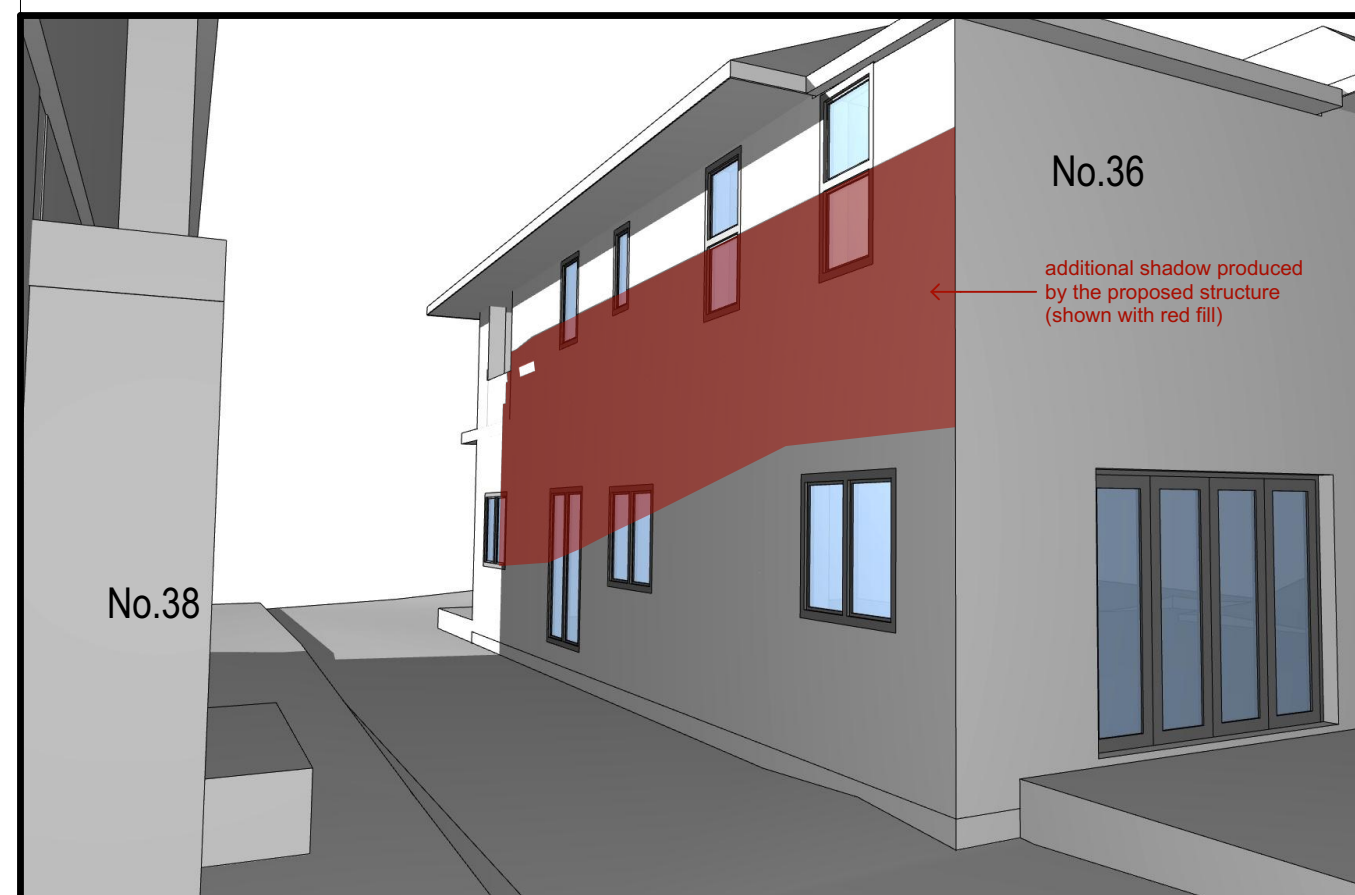

9am Proposed

10am Proposed

11am Proposed

12pm Proposed

CERTIFICATION OF SHADOW DIAGRAMS

DECLARATION: I hereby certify that the shadow diagrams submitted with the proposal at:

for the erection of:
New dwelling

- In accordance with the survey (prepared by a registered surveyor) which is required with the proposal;
- Drawn to true north as indicated in the survey provided by the client;
- To indicate shadow cast by the proposal at 9am, noon, 3pm of June 21st;
- If applicable elevations of adjoining premises showing existing shadows.

CERTIFIER: ■ Mr □ Mrs □ Ms □ Other
Company Name: Shadow Diagrams
Full Family Name:
Full Given Names:
Qualification:
Computer Technician:

SIGNATURE: 

DATE: 10/12/2019

- DISCLAIMER:**
- Survey topography, building heights and fence heights used to produce these shadow diagrams have been provided by others
 - Survey provided by others was received in JPEG-format
 - Survey provided by others was received in PDF format
 - Shadow diagrams have been calculated and drawn to the best of our ability with all due care taken to ensure their accuracy
 - Existing landscaping and vegetation has not been modelled

Revision

Rev	Description	Date

General Notes

Client

Project Name
New dwelling shadow study

Drawing Title:
Shadow Diagram Sheet 1 - Existing and Proposed Analysis

Scale: 1:200 Date: 10/12/2019

Status: DA Technician:

Project No.: Drawing No.:

1017



W: shadowdiagrams.net.au
E: projects@shadowdiagrams.net.au
P: (02) 9030 0370

Plot Date: 10/12/2019

1pm, June 21st

Altitude 30.23°
Azimuth 126.13°

2pm, June 21st

Altitude 25.23°
Azimuth 140.62°

3pm, June 21st

Altitude 17.74°
Azimuth 153.02°

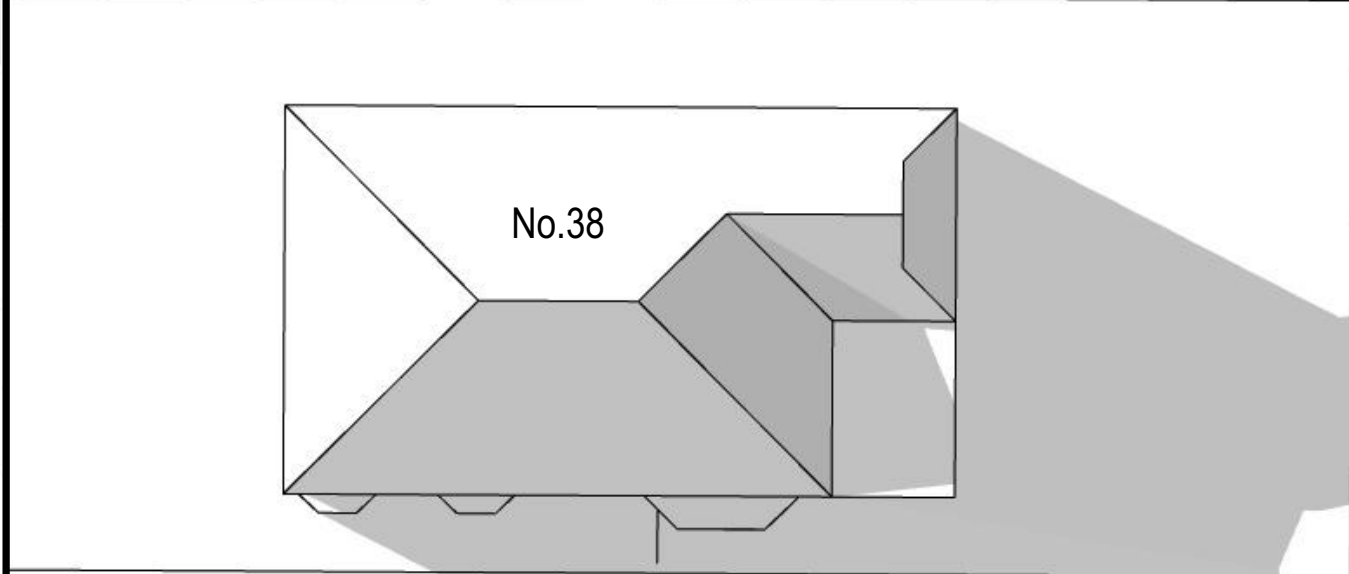
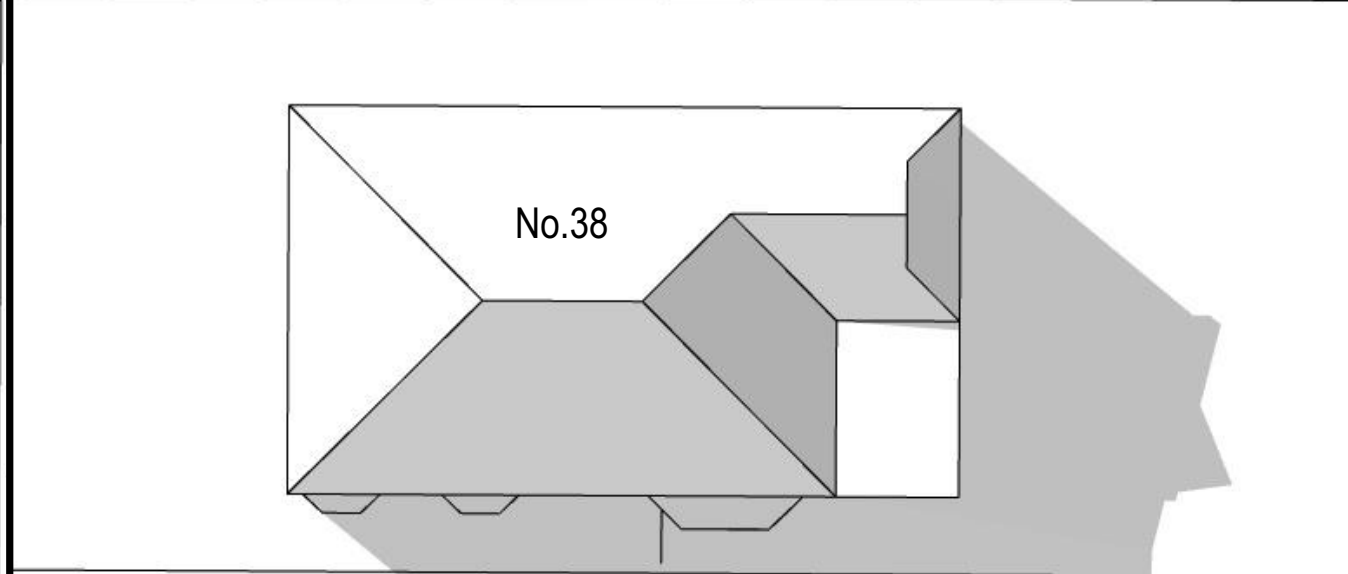
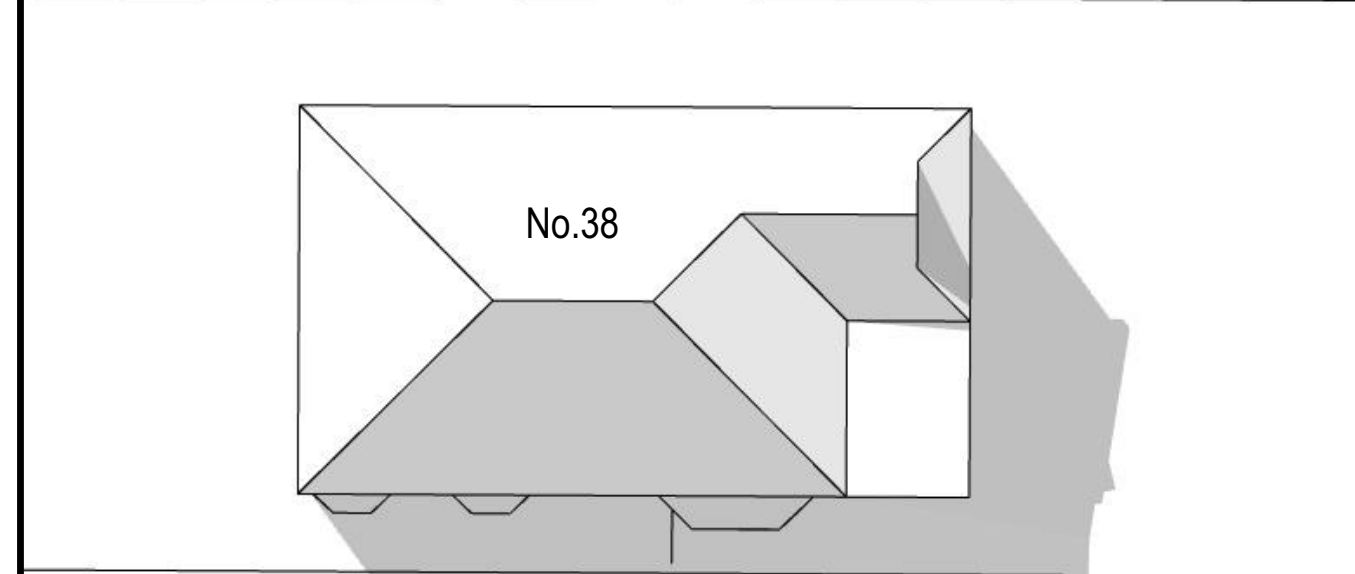

1pm Existing

2pm Existing

3pm Existing

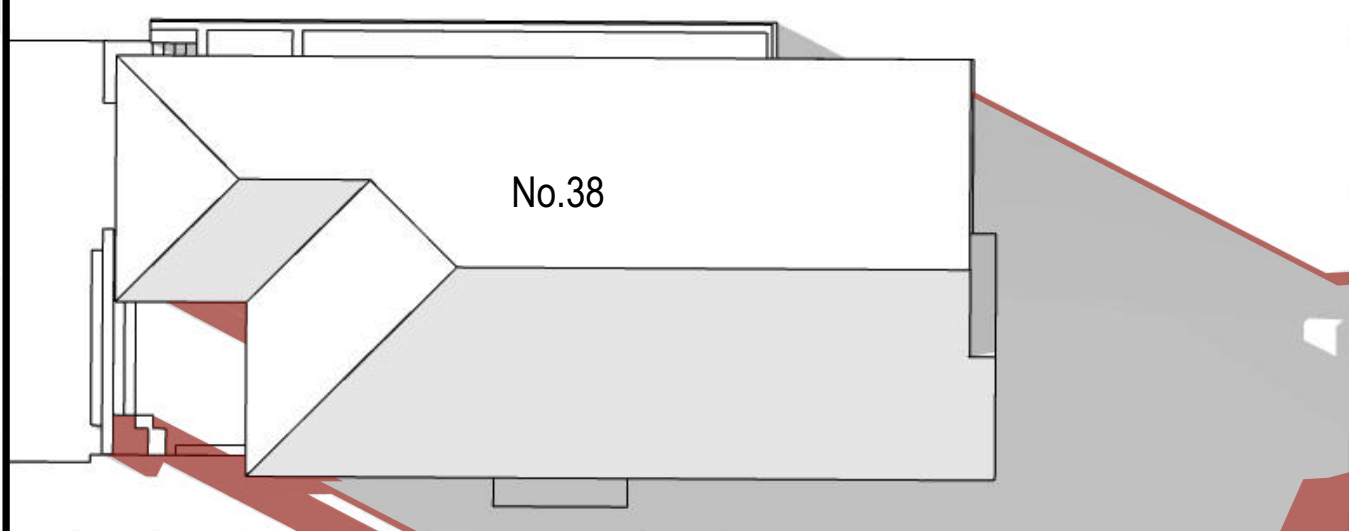
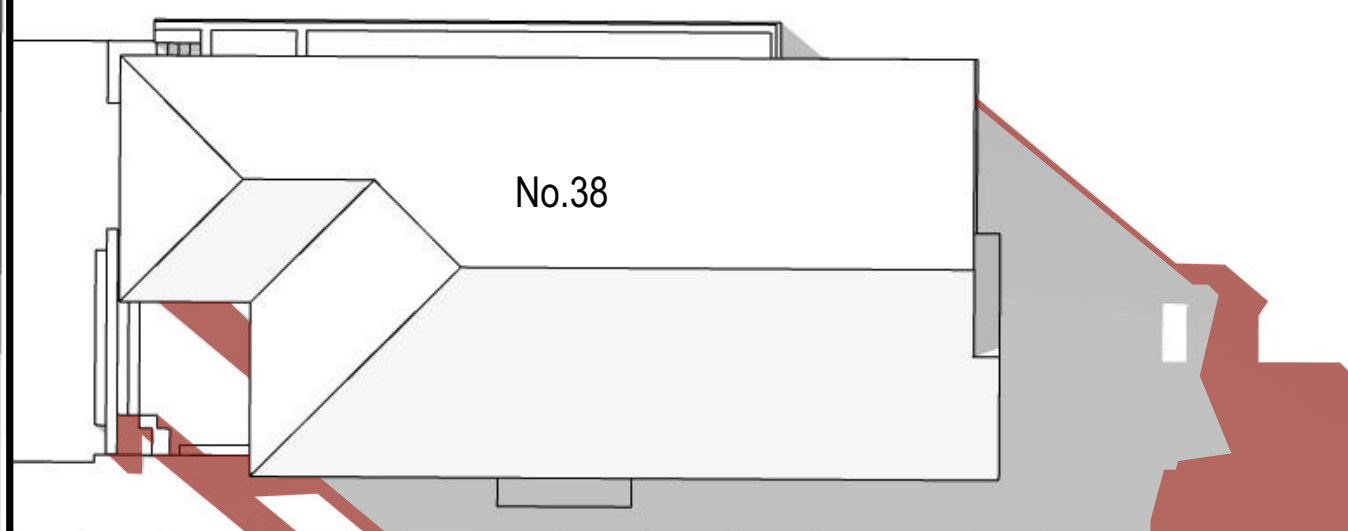
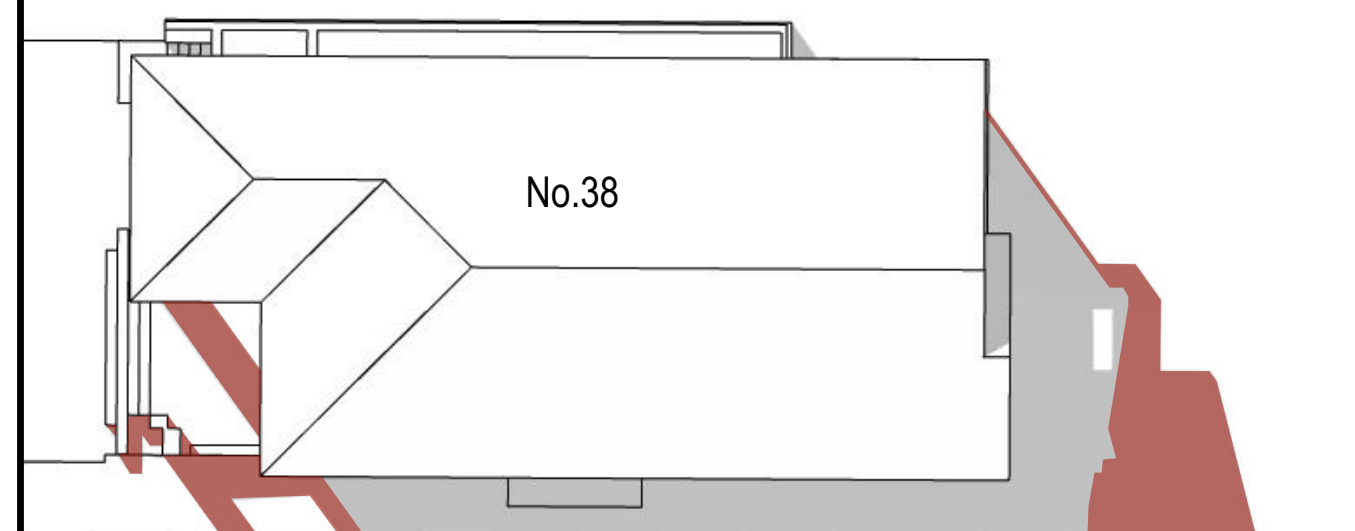

1pm Proposed

2pm Proposed

3pm Proposed

CERTIFICATION OF SHADOW DIAGRAMS

DECLARATION: I hereby certify that the shadow diagrams submitted with the proposal at:

for the erection of:

New dwelling

- In accordance with the survey (prepared by a registered surveyor) which is required with the proposal;
- Drawn to true north as indicated in the survey provided by the client;
- To indicate shadow cast by the proposal at 9am, noon, 3pm of June 21st;
- If applicable elevations of adjoining premises showing existing shadows.

CERTIFIER: ■ Mr □ Mrs □ Ms □ Other
 Company Name: Shadow Diagrams
 Full Family Name:
 Full Given Names:
 Qualification:
 Computer Technician:

SIGNATURE: _____

DATE: 10/12/2019

DISCLAIMER:

- Survey topography, building heights and fence heights used to produce these shadow diagrams have been provided by others
- Survey provided by others was received in JPEG-format
- Survey provided by others was received in PDF format
- Shadow diagrams have been calculated and drawn to the best of our ability with all due care taken to ensure their accuracy
- Existing landscaping and vegetation has not been modelled

Revision

Rev	Description	Date

General Notes

Client

Project Name

New dwelling shadow study

Drawing Title:

Shadow Diagram Sheet 2 - Existing and Proposed Analysis

Scale: 1:200 Date: 10/12/2019

Status: DA Technician:

Project No.: Drawing No.:

1017



W: shadowdiagrams.net.au
 E: projects@shadowdiagrams.net.au
 P: (02) 9030 0370

Plot Date: 10/12/2019

9am, June 21st

Altitude 18.31°
Azimuth 67.04°

10am, June 21st

Altitude 25.65°
Azimuth 79.59°

11am, June 21st

Altitude 30.46°
Azimuth 94.20°

12pm, June 21st

Altitude 32.07°
Azimuth 110.19°

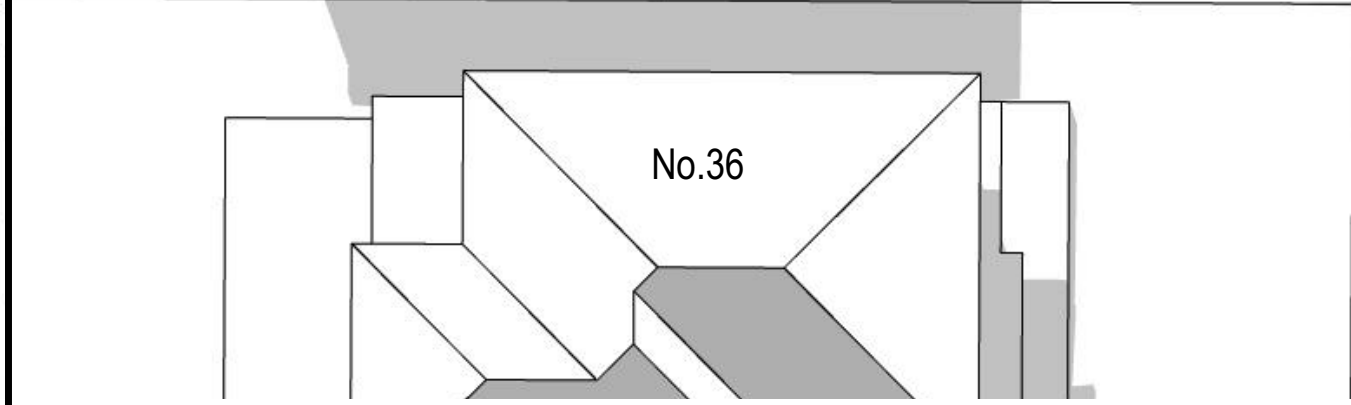
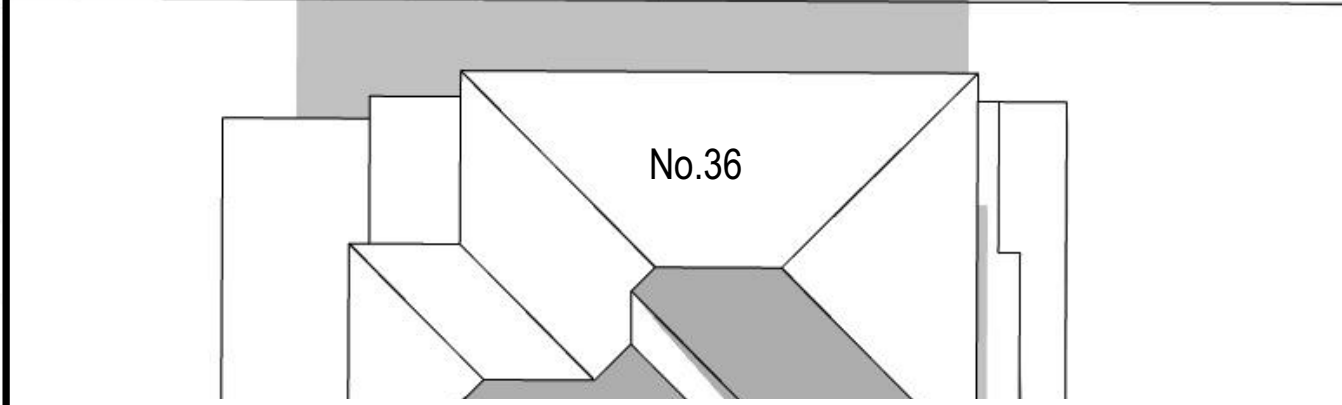
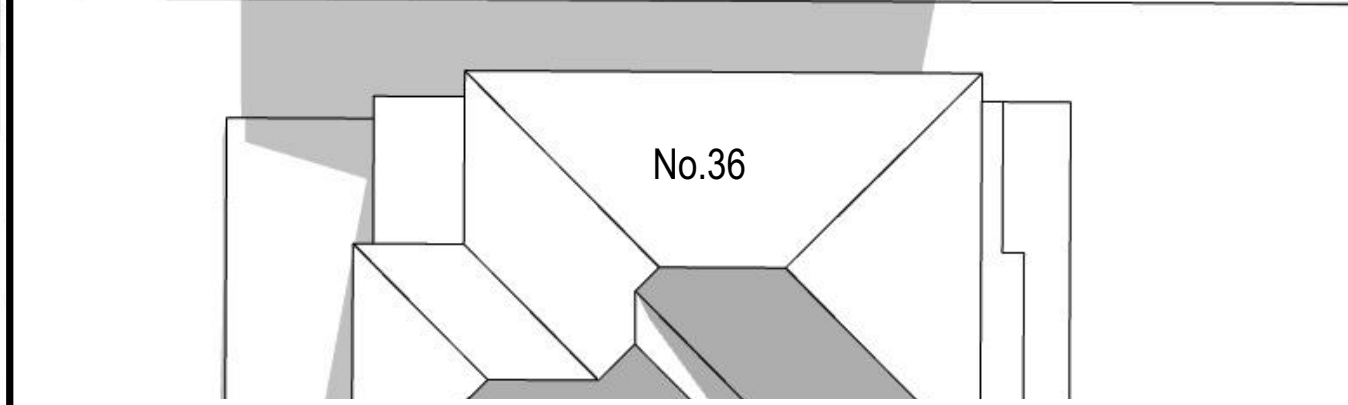
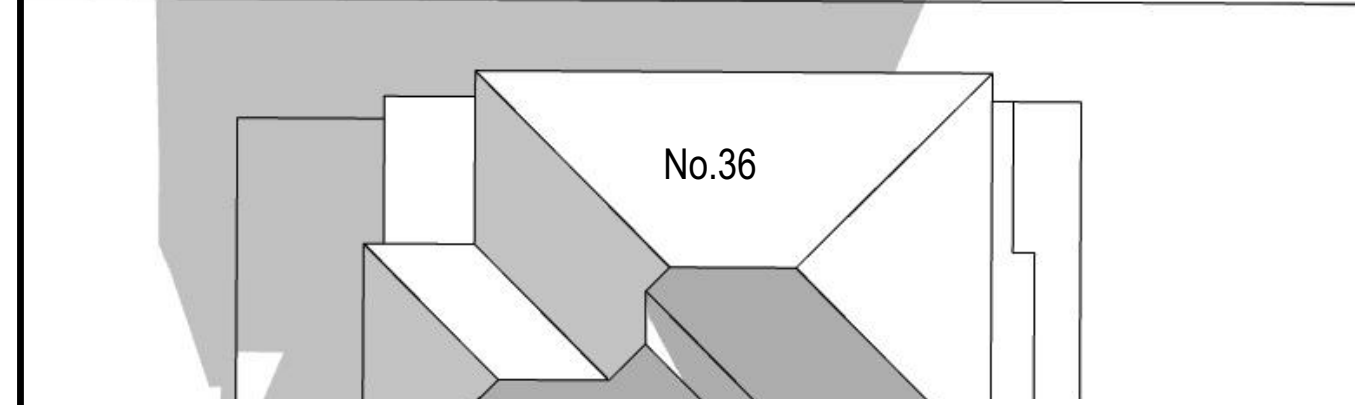
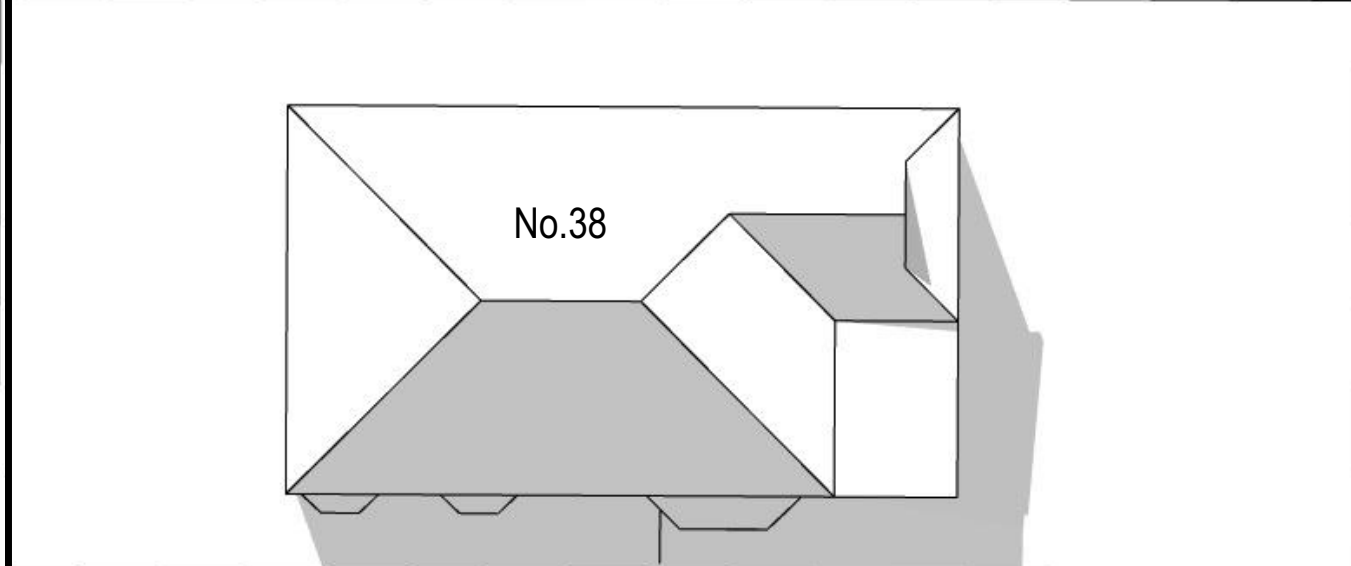
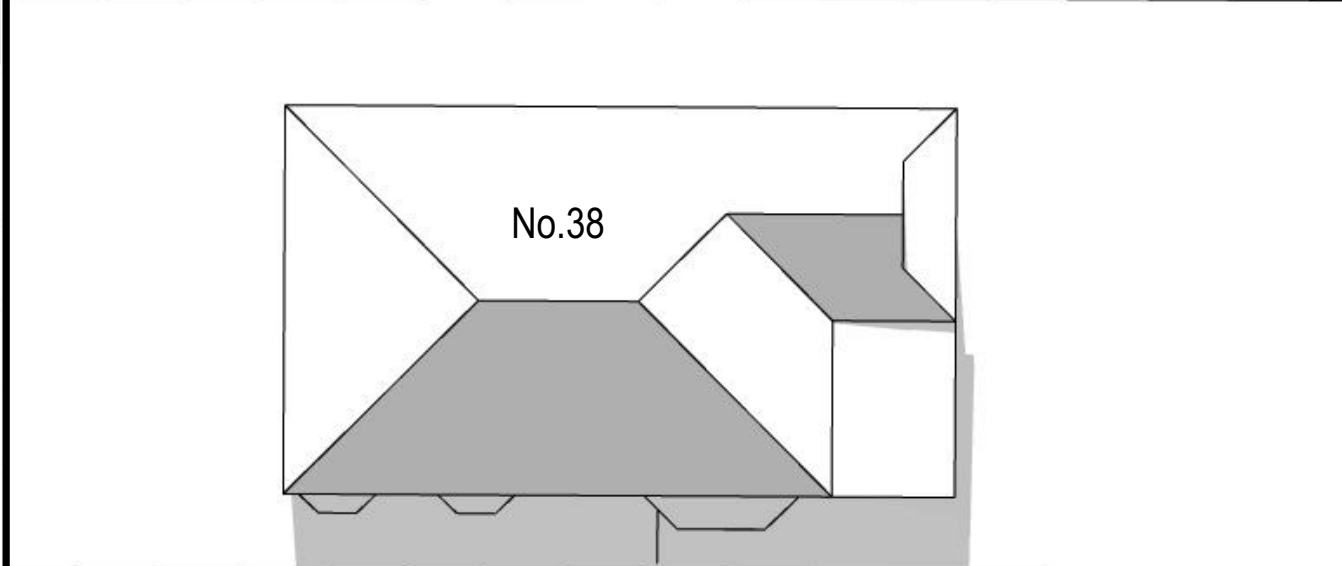
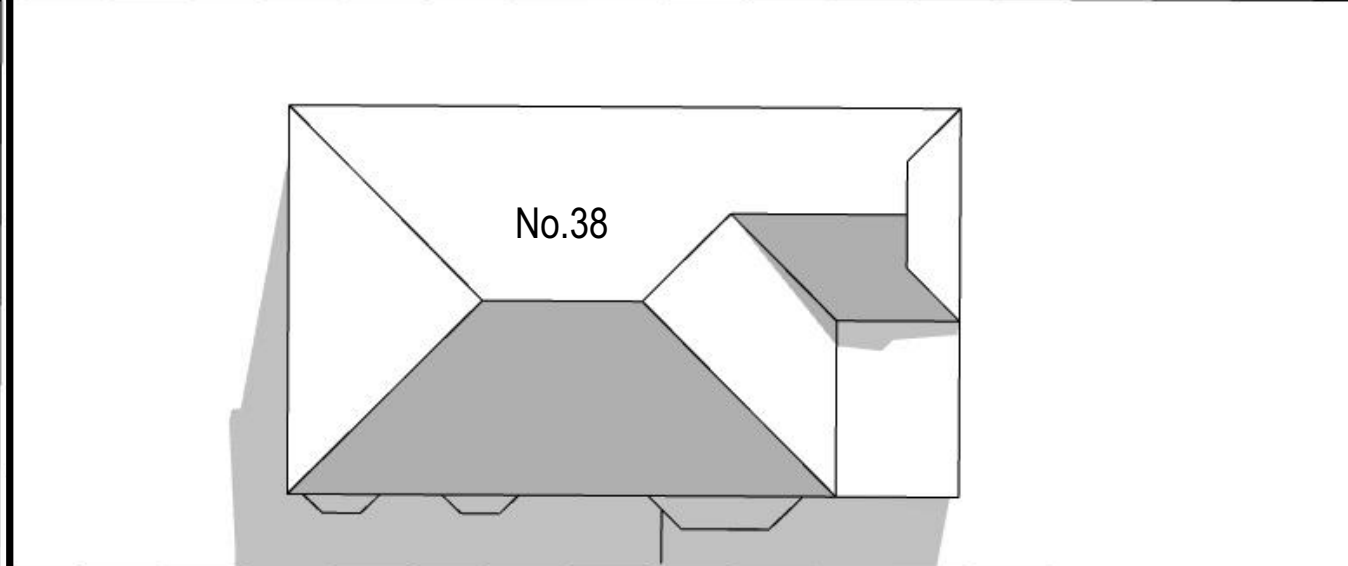
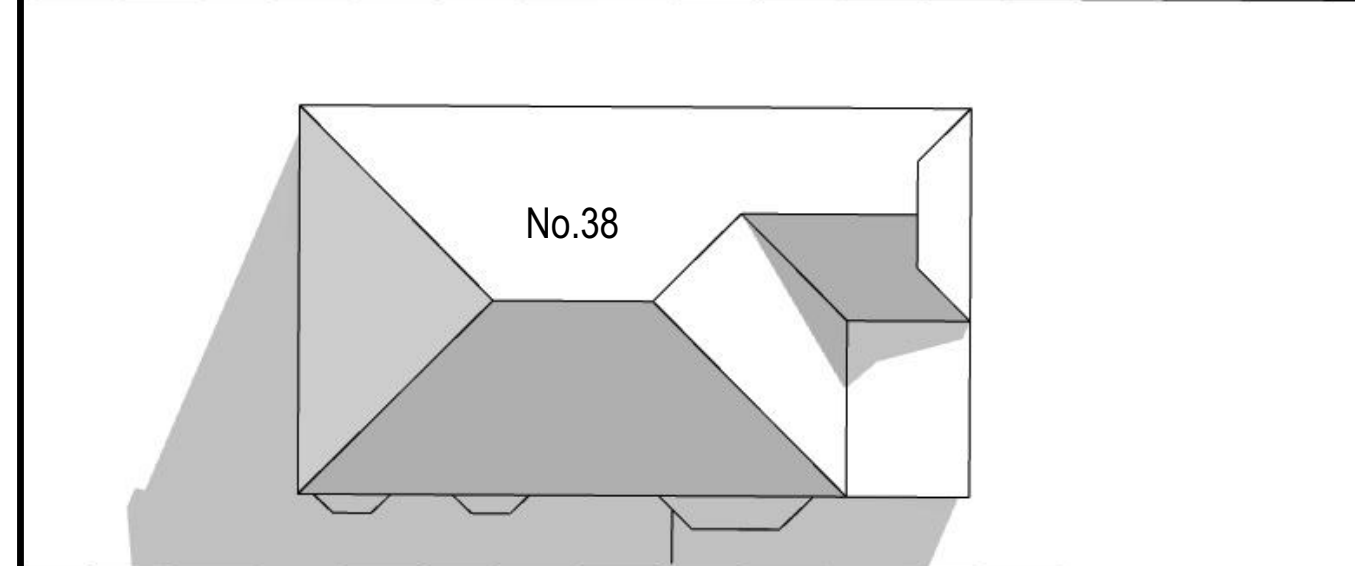
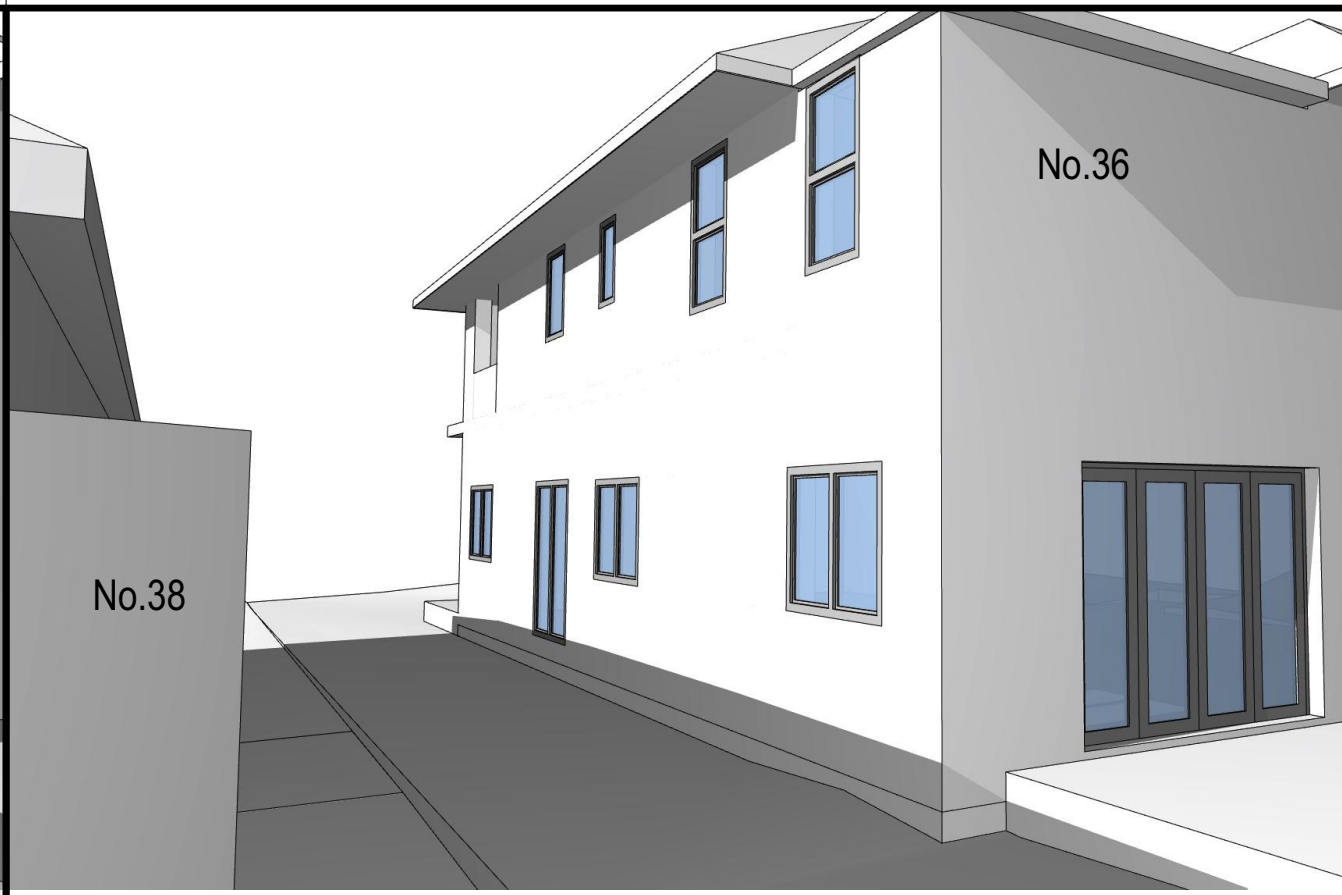
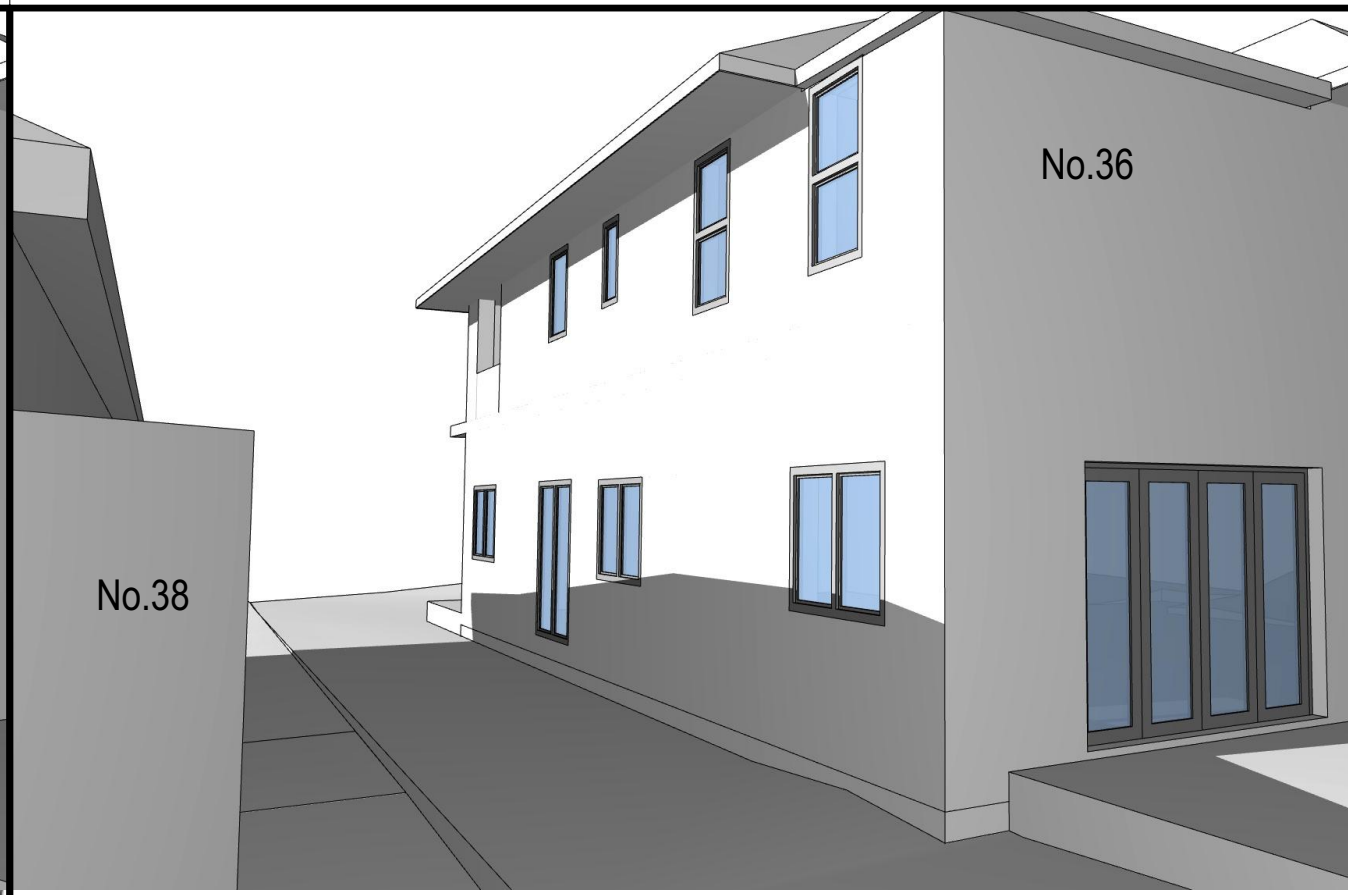

9am Existing

10am Existing

11am Existing

12pm Existing

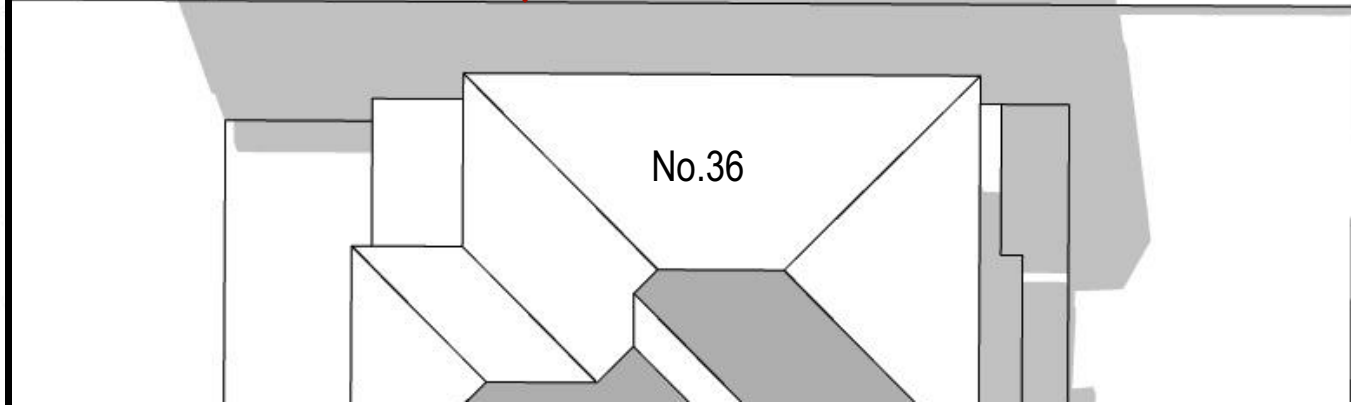
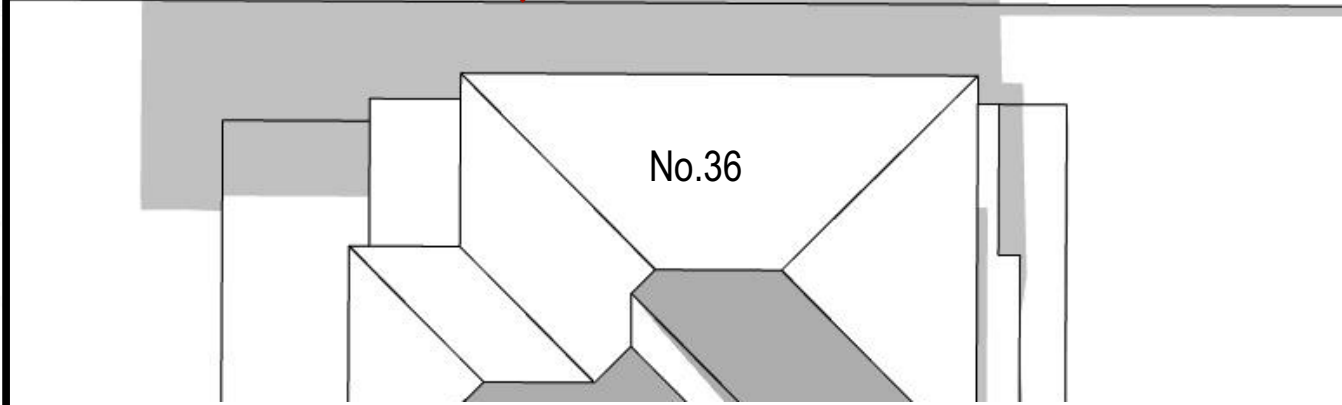
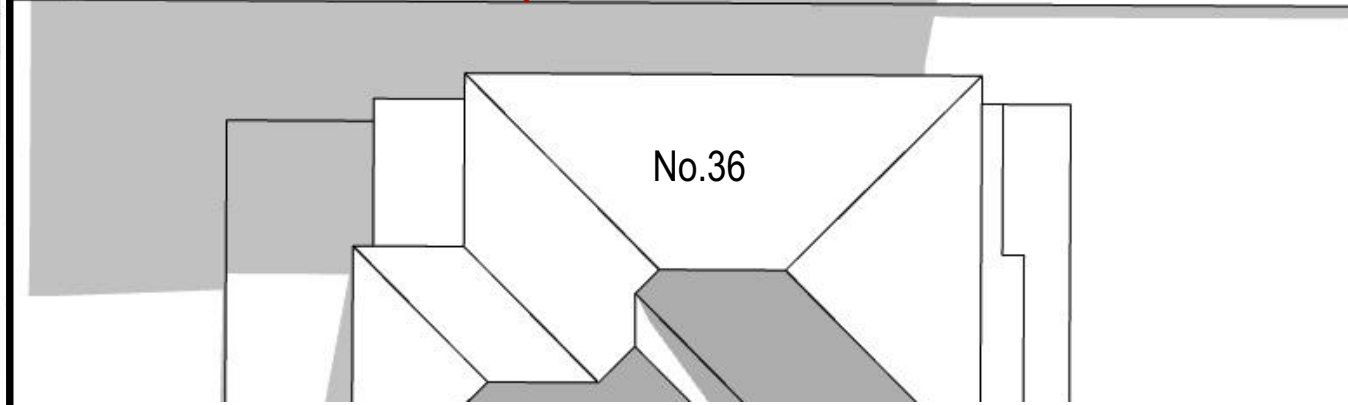
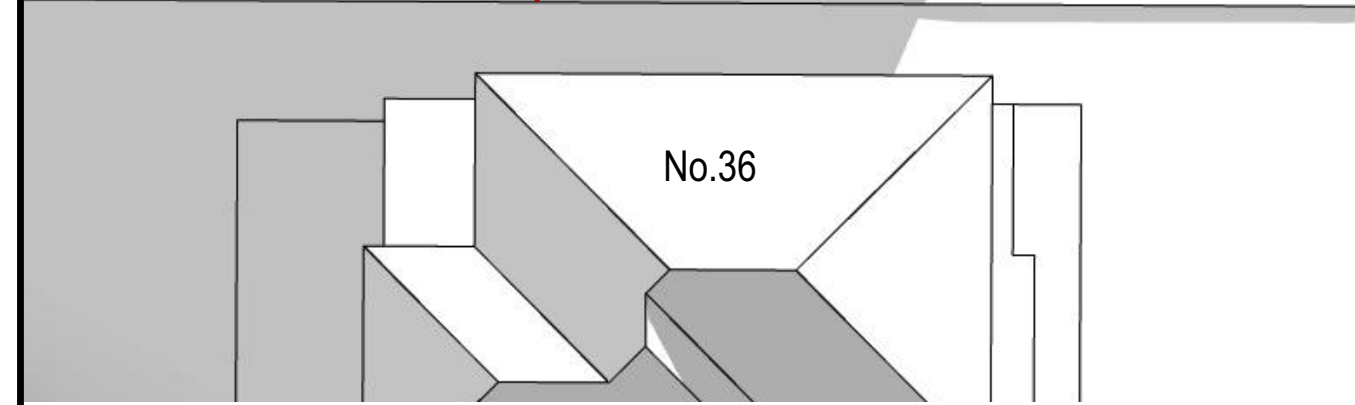
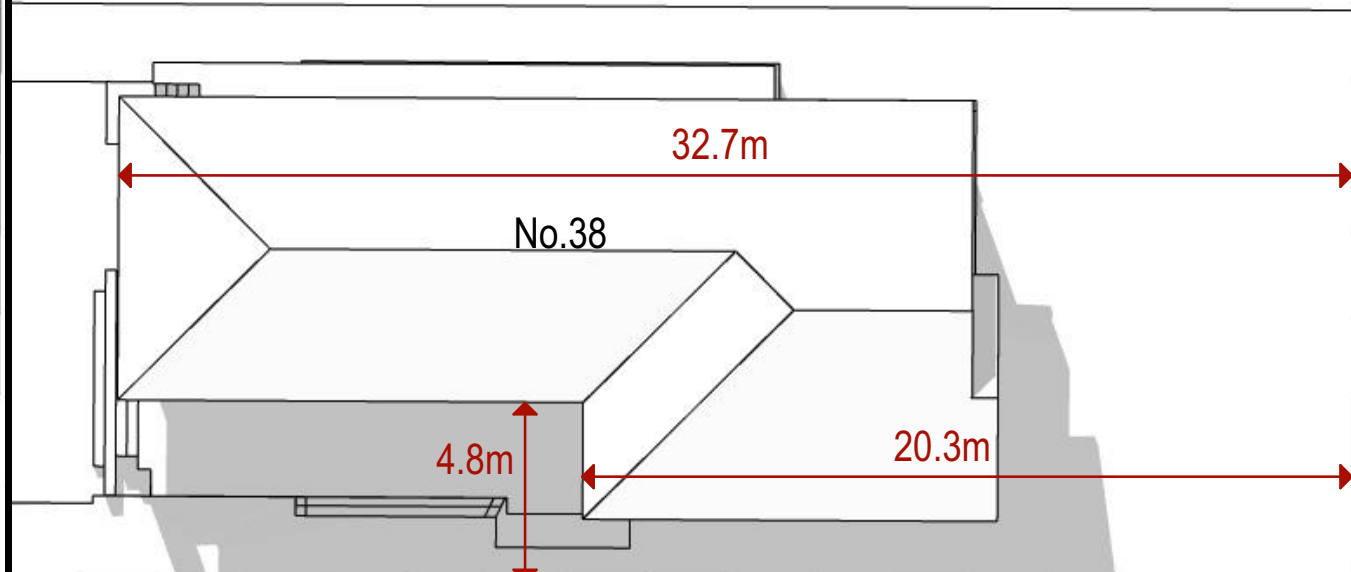
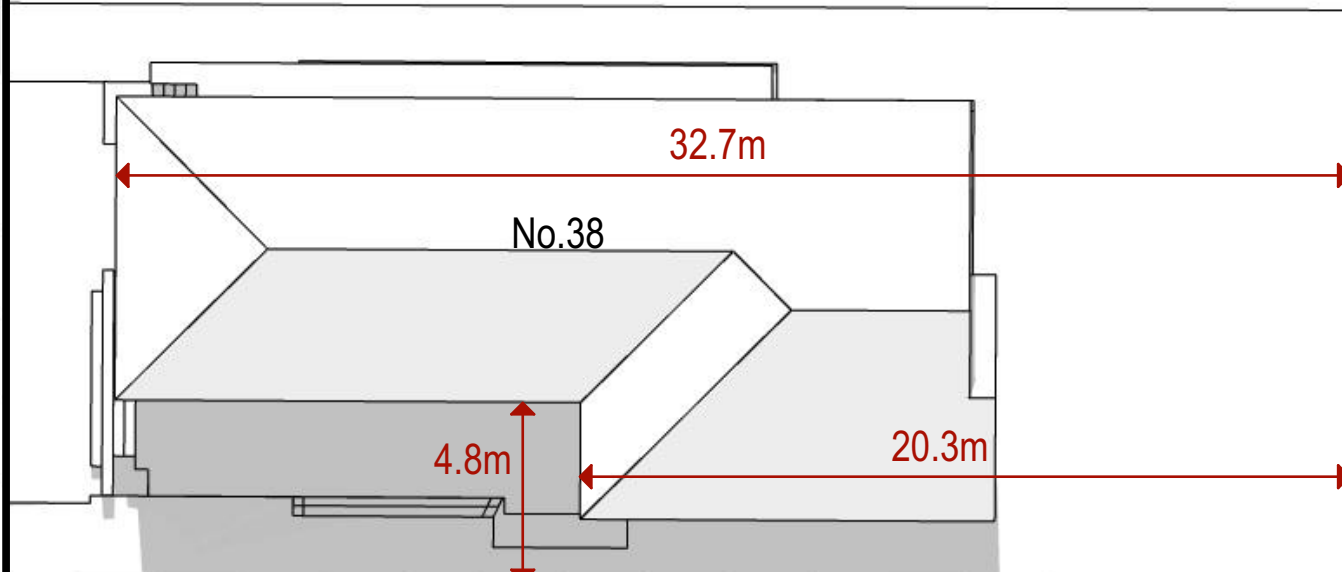
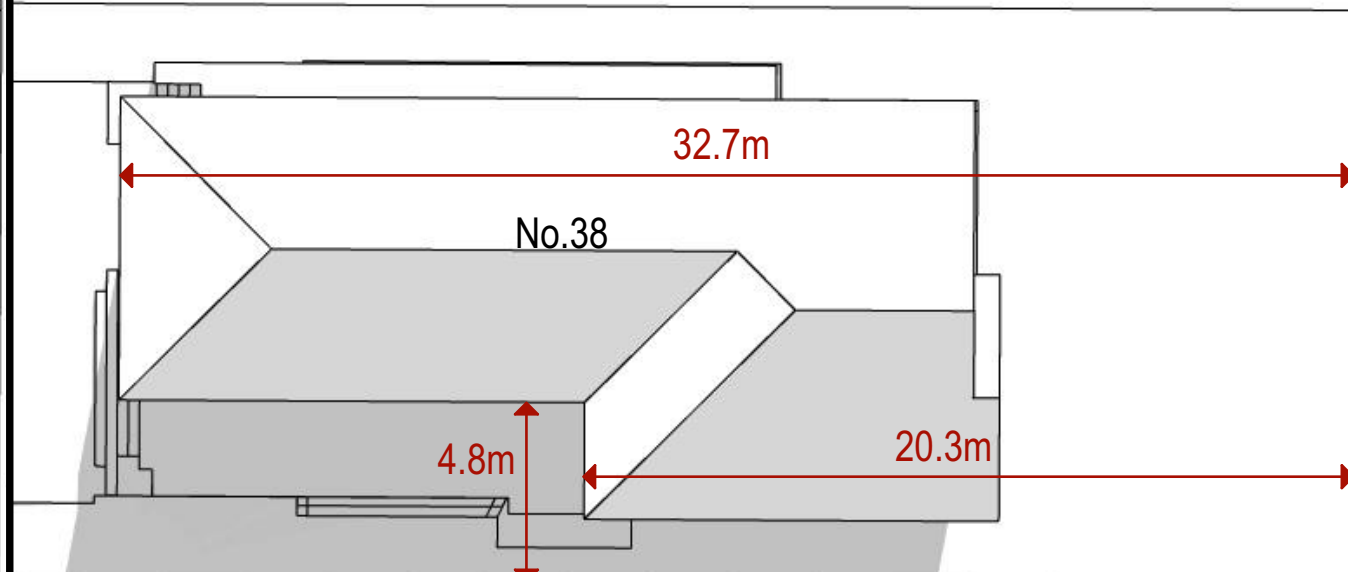
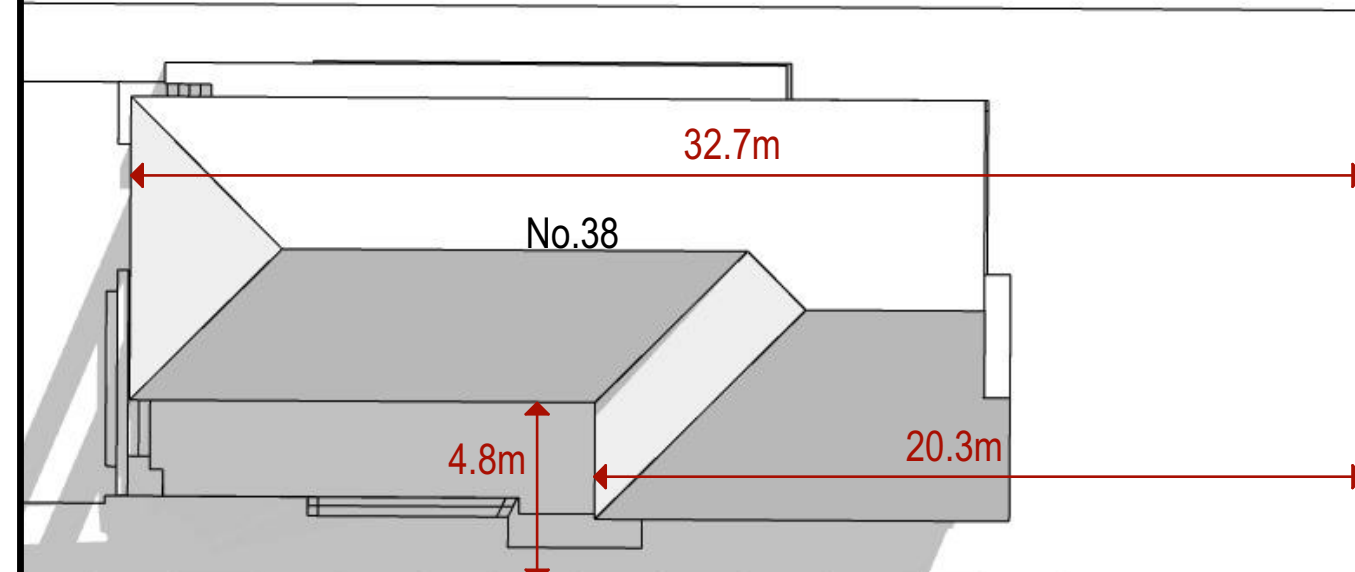
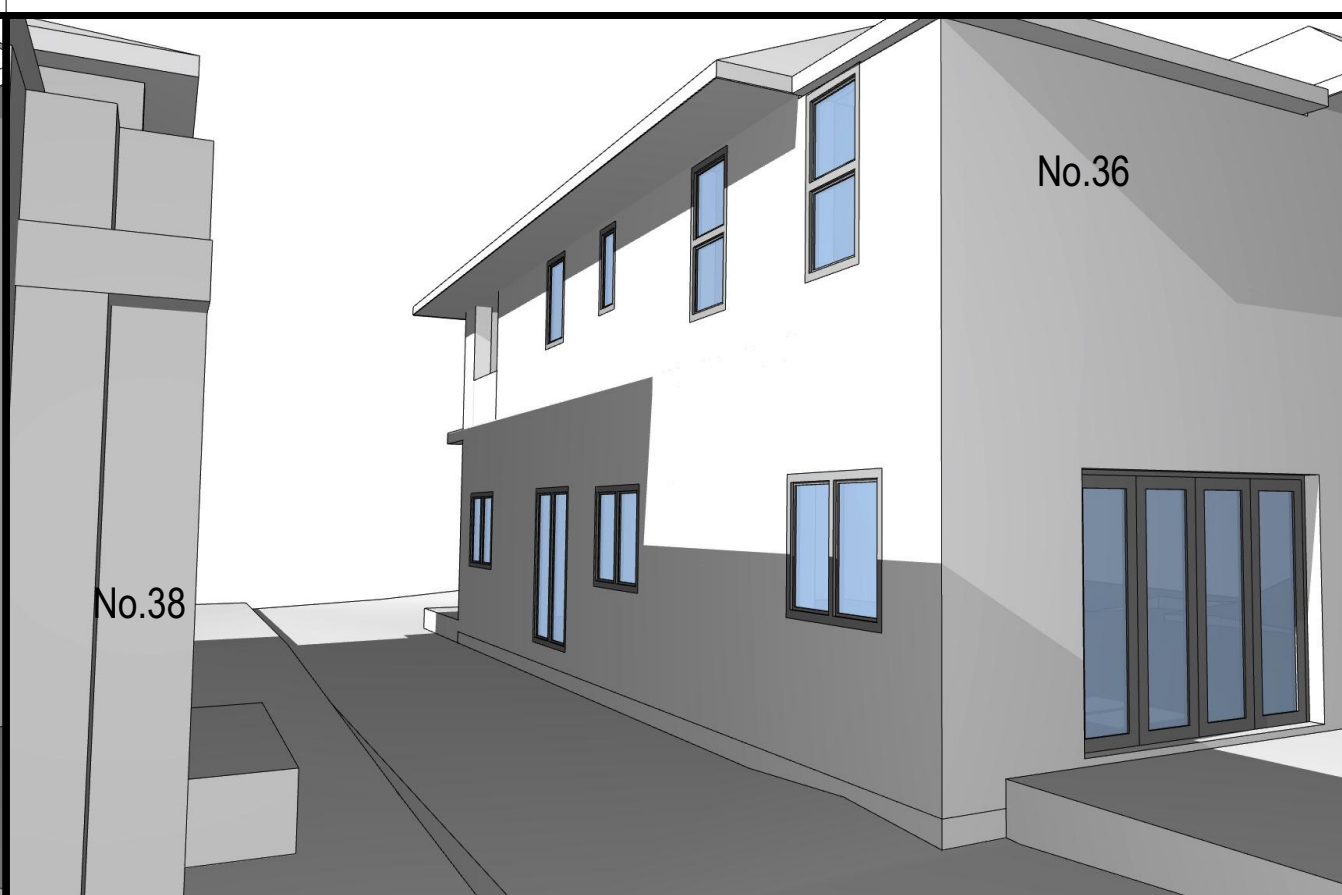
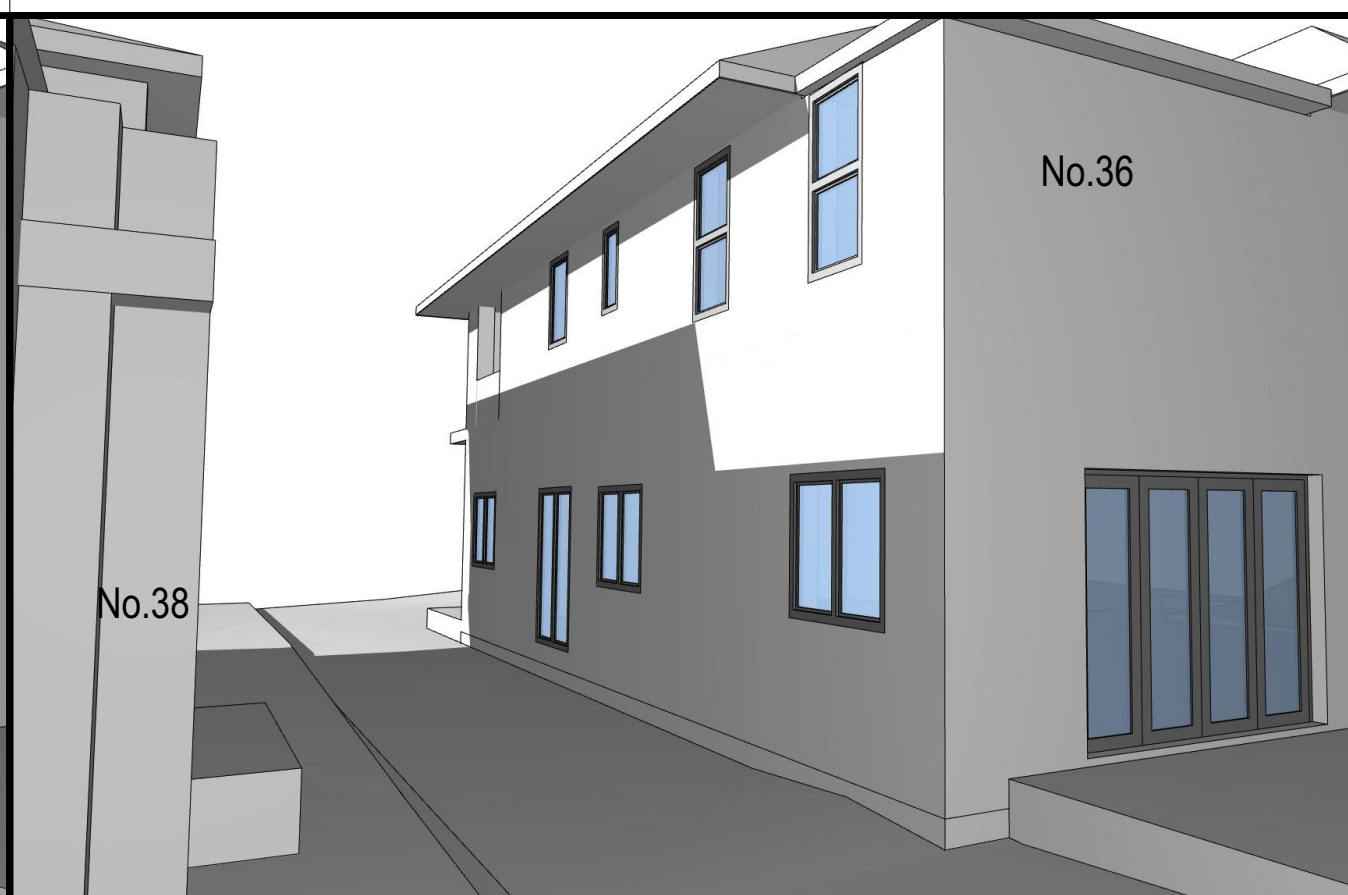
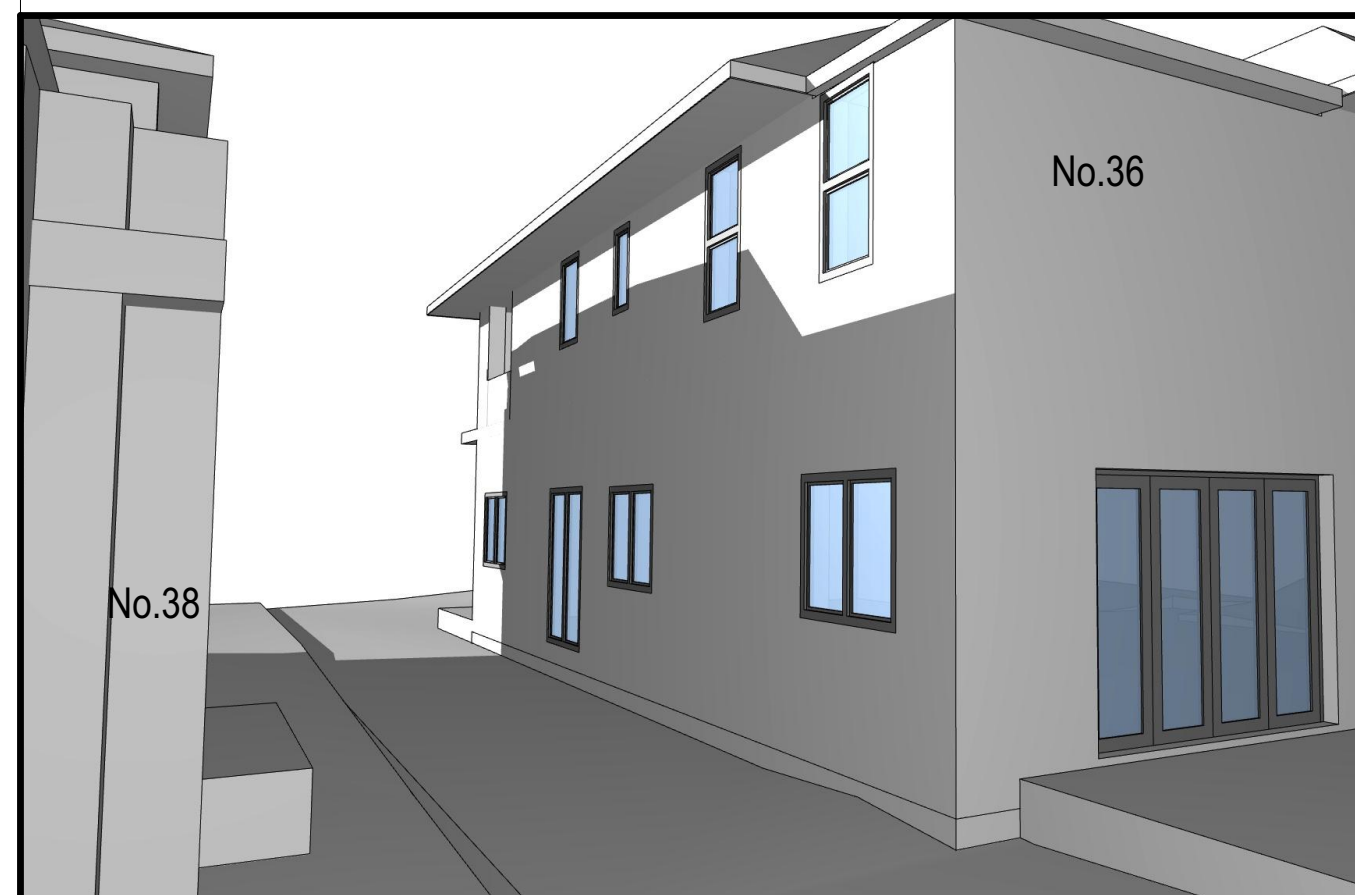

9am Recommended

10am Recommended

11am Recommended

12pm Recommended

CERTIFICATION OF SHADOW DIAGRAMS

DECLARATION: I hereby certify that the shadow diagrams submitted with the proposal at:

for the erection of:
New dwelling

- In accordance with the survey (prepared by a registered surveyor) which is required with the proposal;
- Drawn to true north as indicated in the survey provided by the client;
- To indicate shadow cast by the proposal at 9am, noon, 3pm of June 21st;
- If applicable elevations of adjoining premises showing existing shadows.

CERTIFIER: ■ Mr □ Mrs □ Ms □ Other
Company Name: Shadow Diagrams
Full Family Name:
Full Given Names:
Qualification:
Computer Technician:

SIGNATURE: _____

DATE: 10/12/2019

- DISCLAIMER:**
- Survey topography, building heights and fence heights used to produce these shadow diagrams have been provided by others
 - Survey provided by others was received in JPEG-format
 - Survey provided by others was received in PDF format
 - Shadow diagrams have been calculated and drawn to the best of our ability with all due care taken to ensure their accuracy
 - Existing landscaping and vegetation has not been modelled

Revision

Rev	Description	Date

General Notes

Client

Project Name
New dwelling shadow study

Drawing Title:
Shadow Diagram Sheet 3 - Existing and Recommendation Analysis

Scale: 1:200 Date: 10/12/2019

Status: DA Technician:

Project No.: Drawing No.:

1017



W: shadowdiagrams.net.au
E: projects@shadowdiagrams.net.au
P: (02) 9030 0370

Plot Date: 10/12/2019

1pm, June 21st

Altitude 30.23°
Azimuth 126.13°

2pm, June 21st

Altitude 25.23°
Azimuth 140.62°

3pm, June 21st

Altitude 17.74°
Azimuth 153.02°

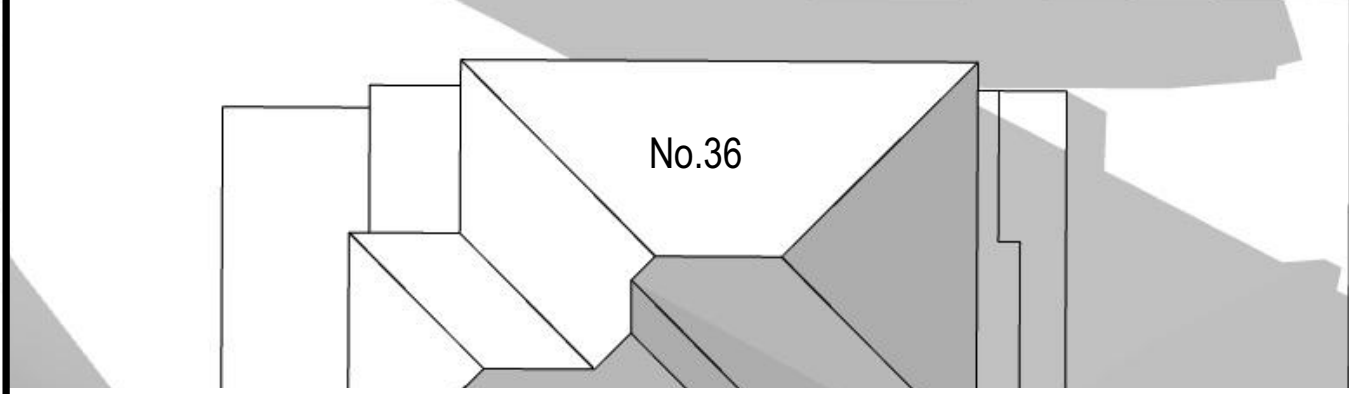
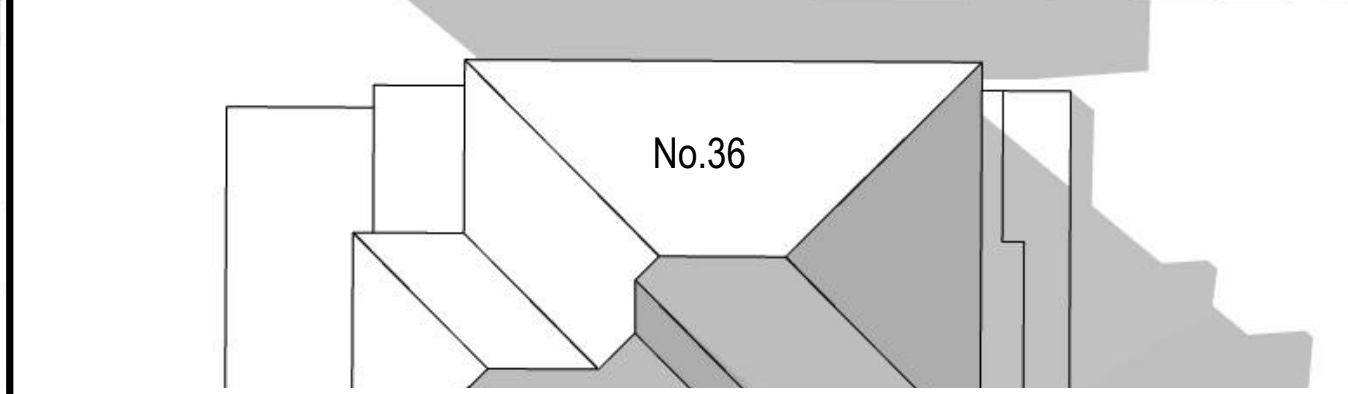
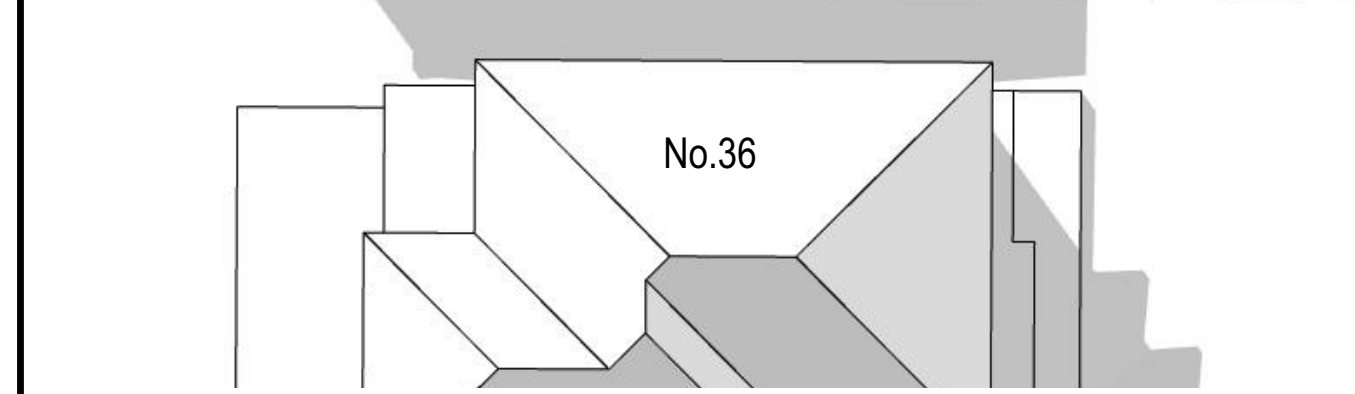
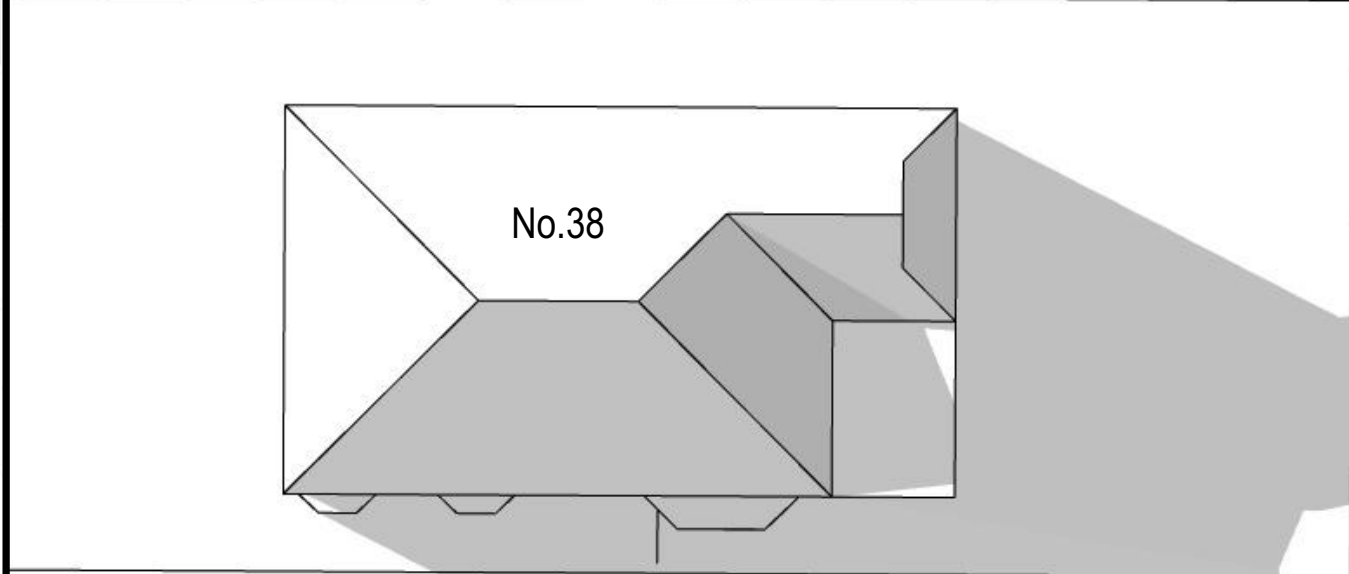
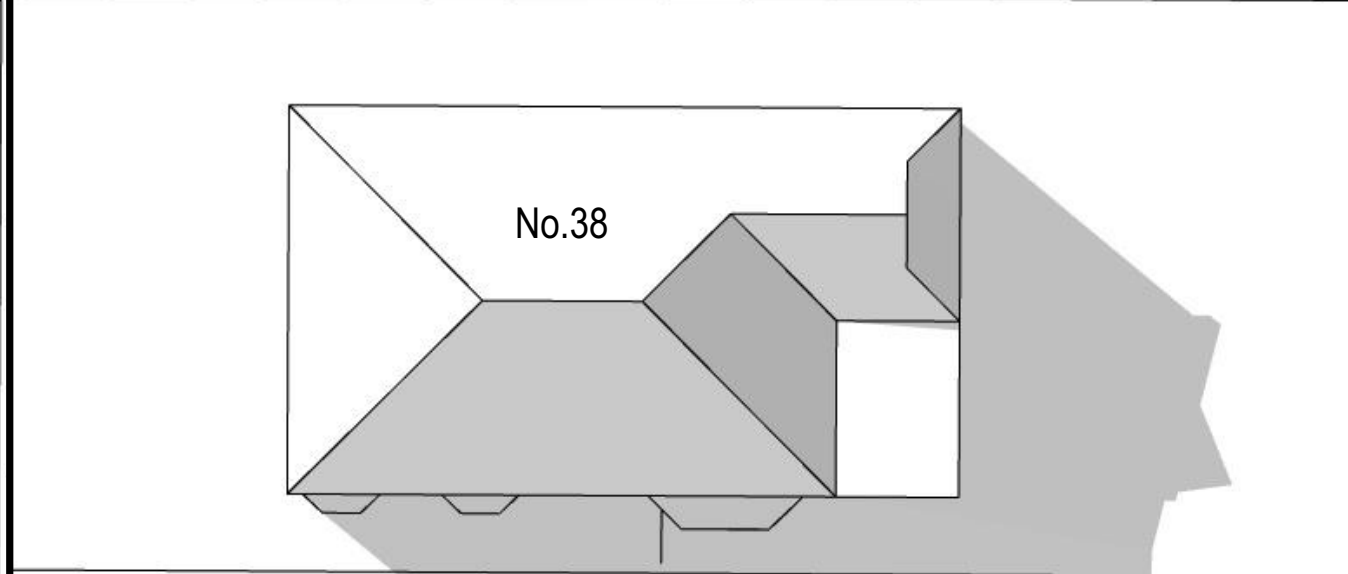
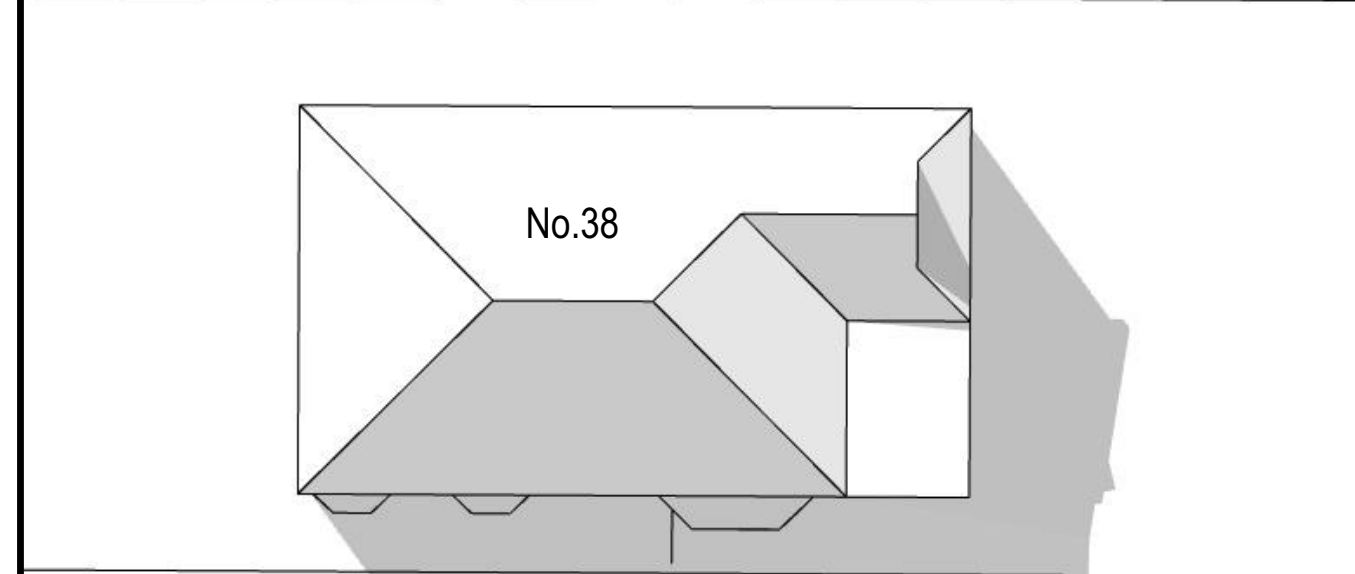

1pm Existing

2pm Existing

3pm Existing

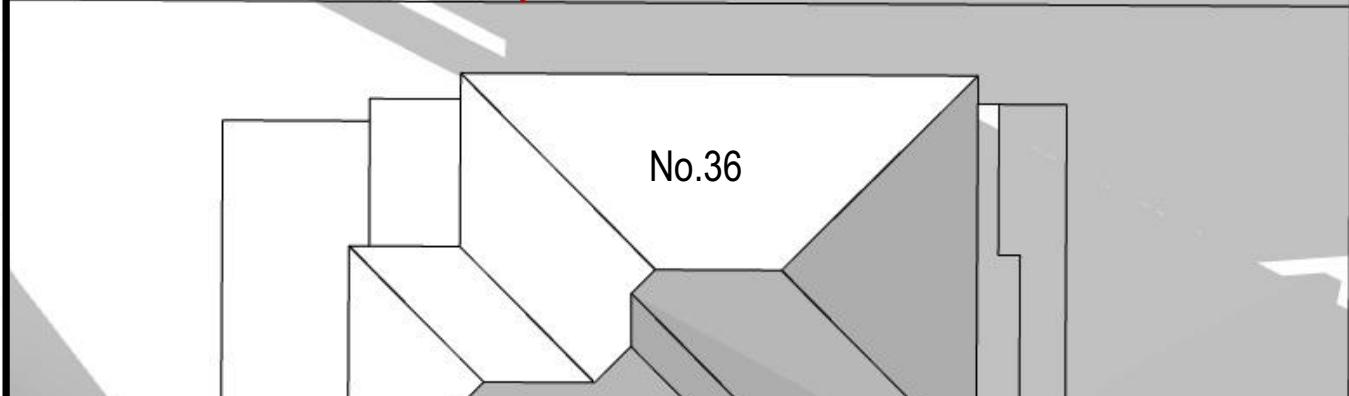
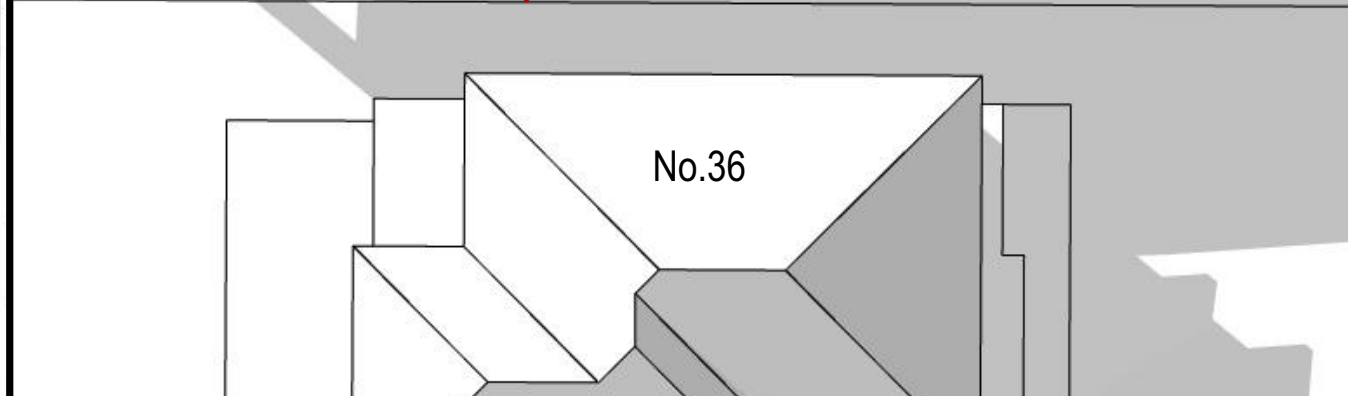
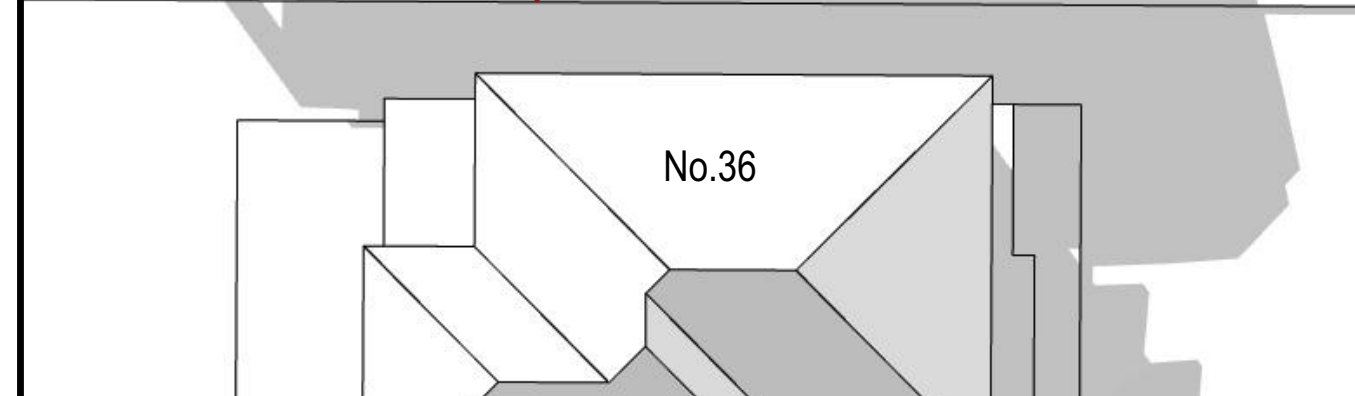
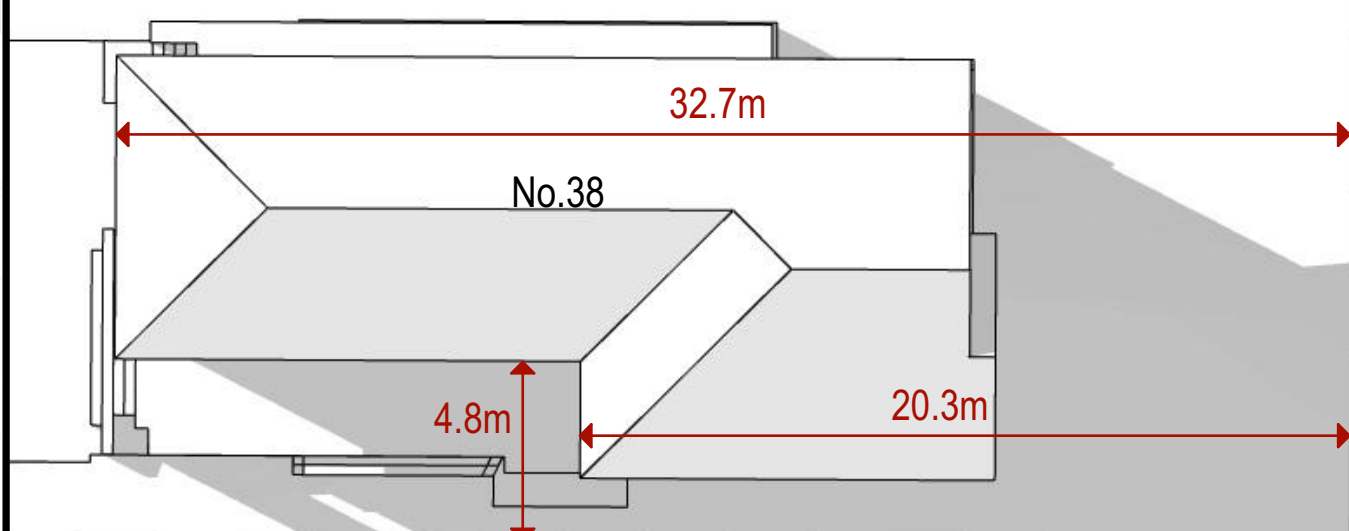
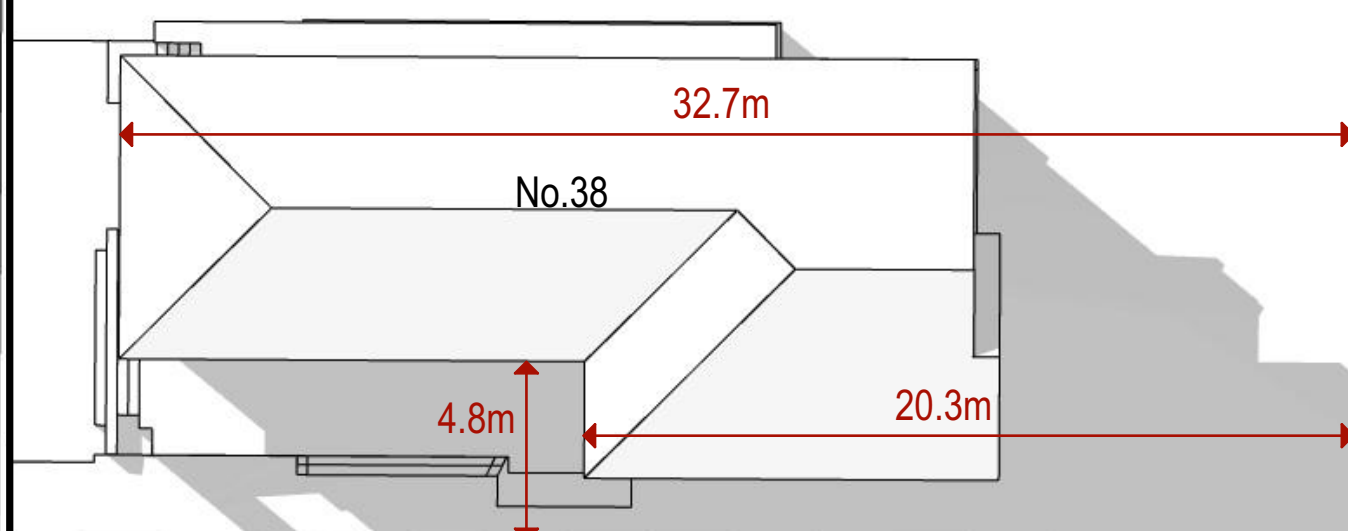
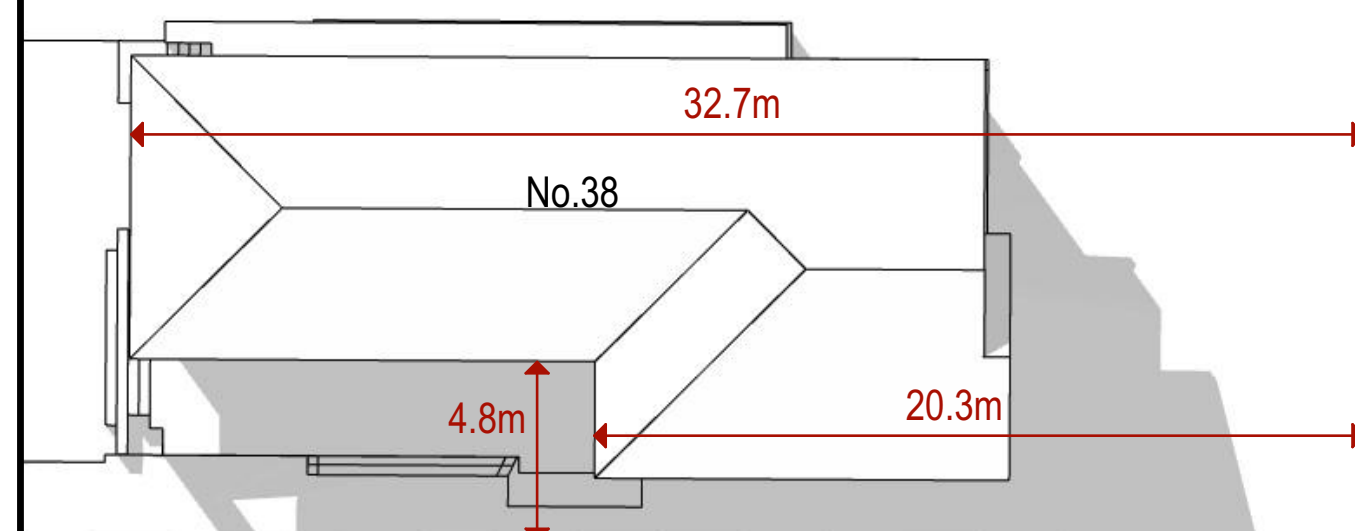

1pm Recommended

2pm Recommended

3pm Recommended

CERTIFICATION OF SHADOW DIAGRAMS

DECLARATION: I hereby certify that the shadow diagrams submitted with the proposal at:

for the erection of:

New dwelling

- In accordance with the survey (prepared by a registered surveyor) which is required with the proposal;
- Drawn to true north as indicated in the survey provided by the client;
- To indicate shadow cast by the proposal at 9am, noon, 3pm of June 21st;
- If applicable elevations of adjoining premises showing existing shadows.

CERTIFIER: Mr Mrs Ms Other
 Company Name: Shadow Diagrams
 Full Family Name:
 Full Given Names:
 Qualification:
 Computer Technician:

SIGNATURE: _____

DATE: 10/12/2019

- DISCLAIMER:
- Survey topography, building heights and fence heights used to produce these shadow diagrams have been provided by others
 - Survey provided by others was received in JPEG-format
 - Survey provided by others was received in PDF format
 - Shadow diagrams have been calculated and drawn to the best of our ability with all due care taken to ensure their accuracy
 - Existing landscaping and vegetation has not been modelled

Revision

Rev	Description	Date

General Notes

Client

Project Name

New dwelling shadow study

Drawing Title:
 Shadow Diagram Sheet 4 - Existing and Recommendation Analysis

Scale: 1:200 Date: 10/12/2019

Status: DA Technician:

Project No.: Drawing No.:

1017



W: shadowdiagrams.net.au
 E: projects@shadowdiagrams.net.au
 P: (02) 9030 0370

Plot Date: 10/12/2019